

1485L Series

4" Heavy Commercial
Thermally Improved Blind Window

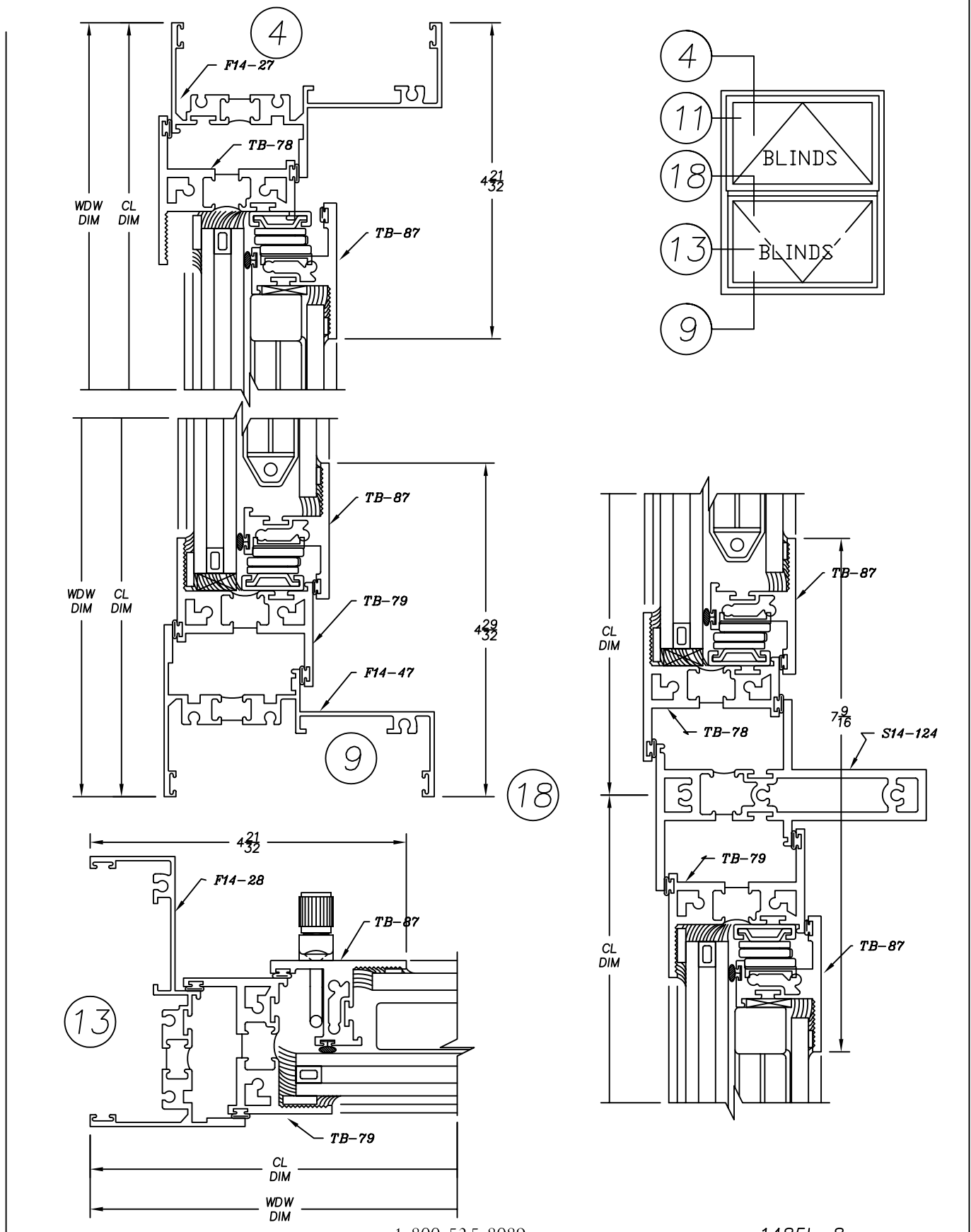

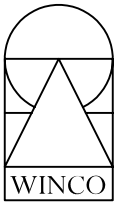

1485L Series

4" Heavy Commercial
Thermally Improved Blind Window

18

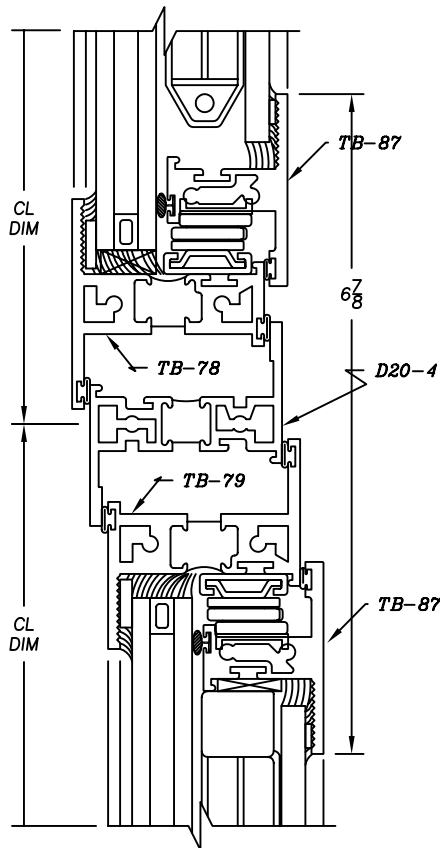

18

HEAVY RAIL

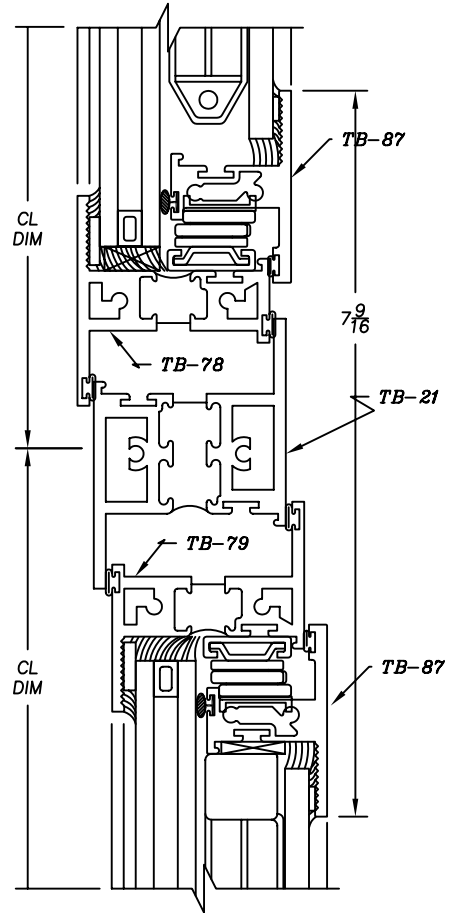

11

