

# 1550H Series

4-1/2" Heavy Commercial

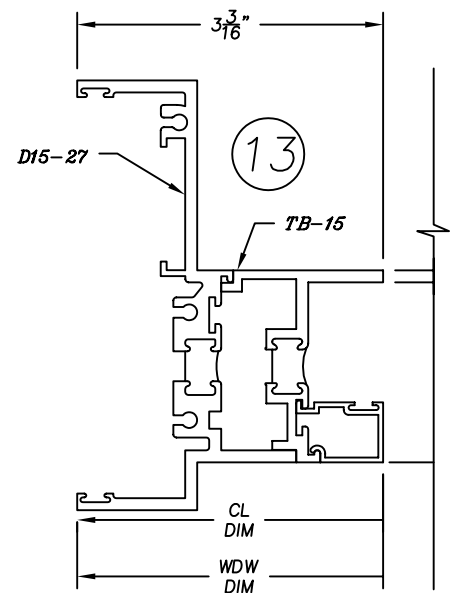

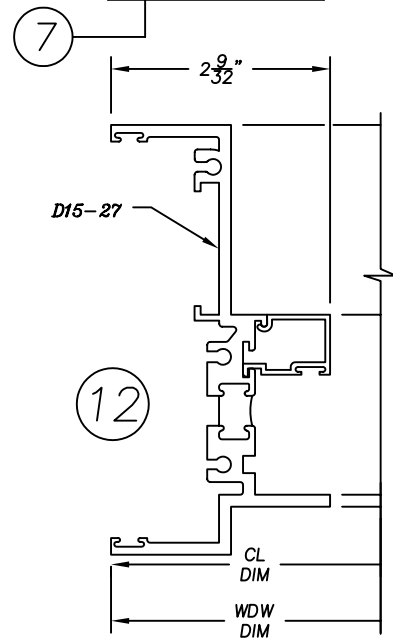
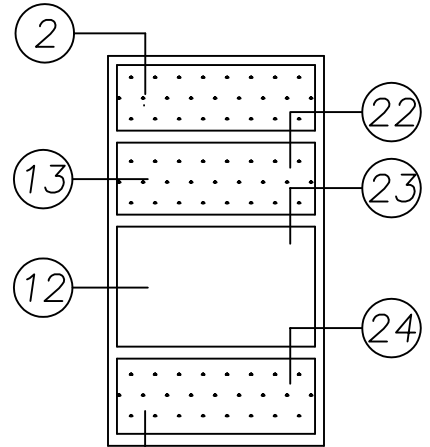
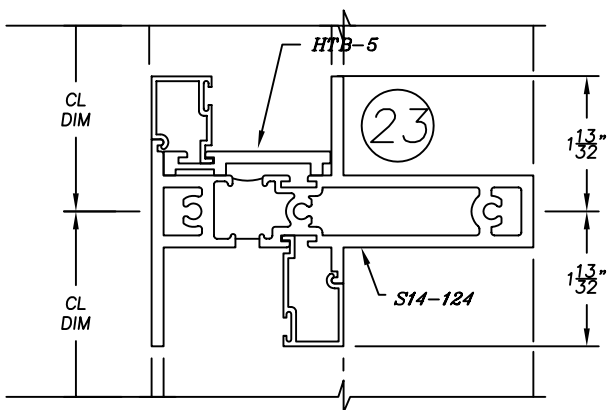
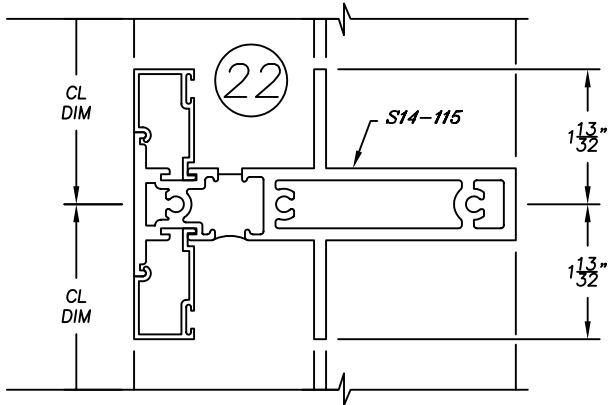
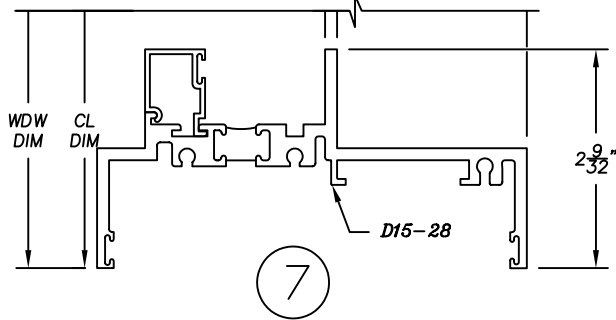
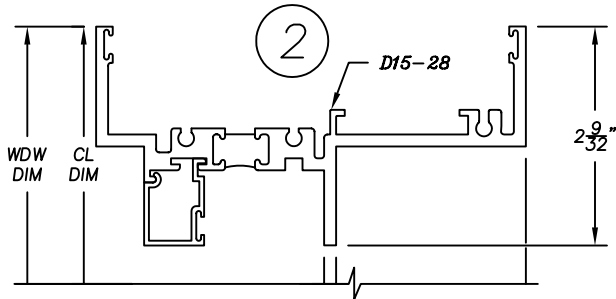
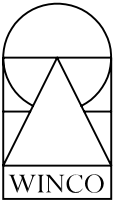

# 1550H Series

4-1/2" Heavy Commercial  
Thermally Improved Window

