

# 1550H Series

4-1/2" Heavy Commercial  
Thermally Improved Window

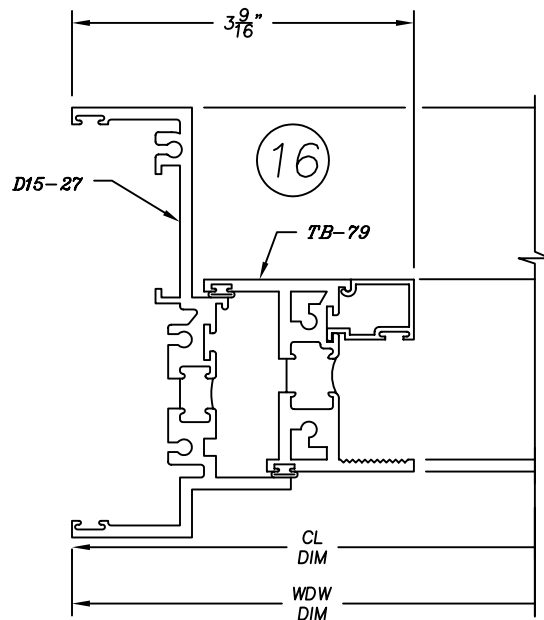

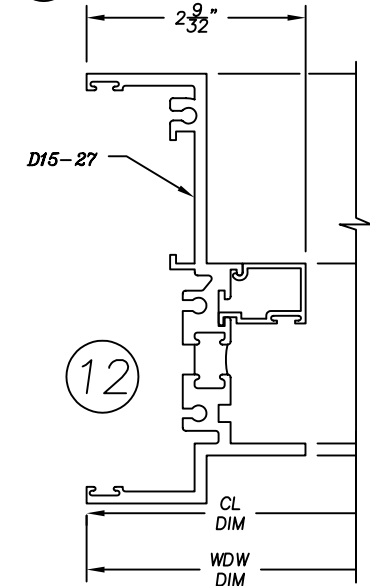
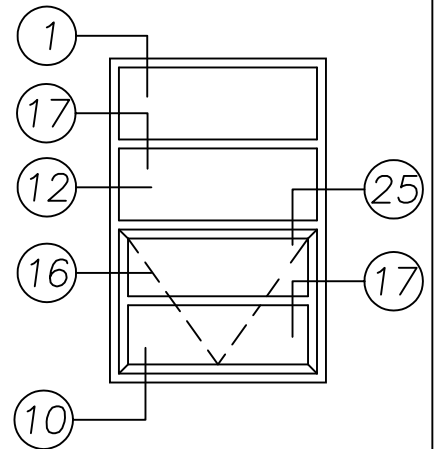
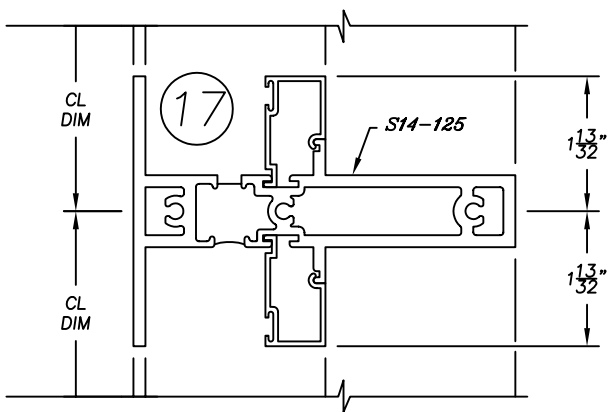
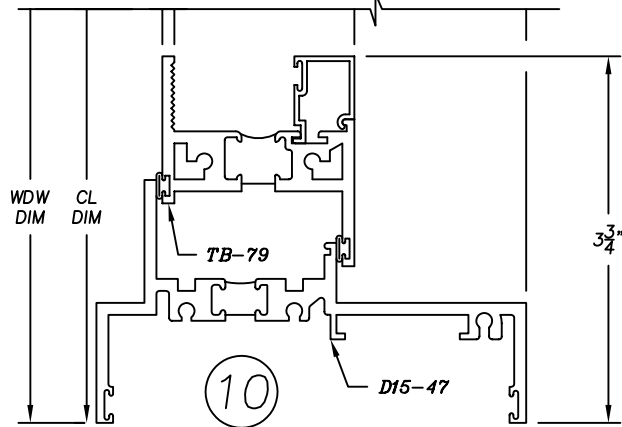
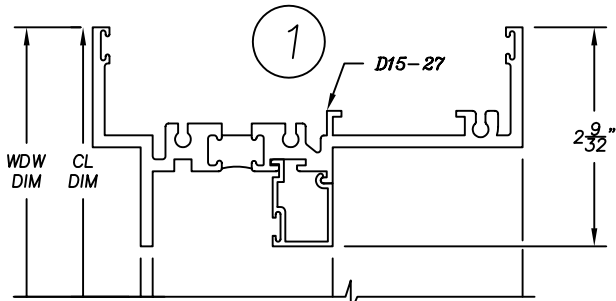
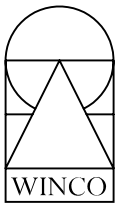

# 1550H Series

4-1/2" Heavy Commercial  
Thermally Improved Window

