

1550H Series

4-1/2" Heavy Commercial
Thermally Improved Window

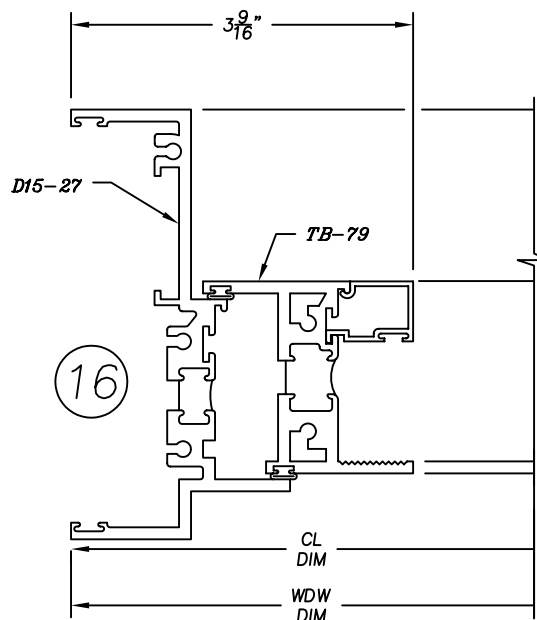

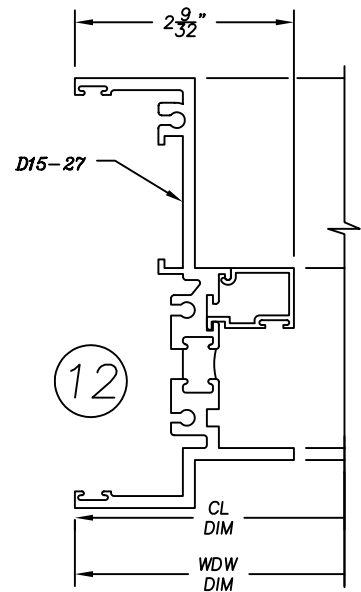
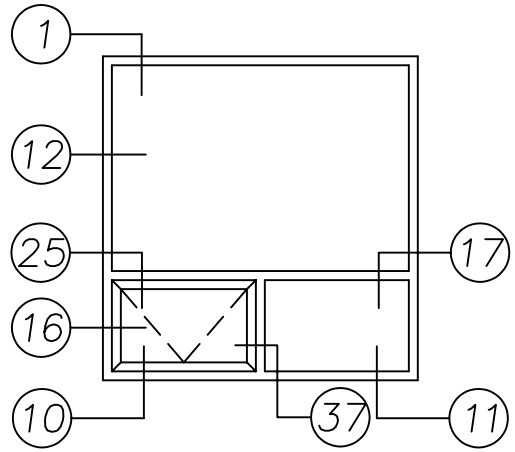
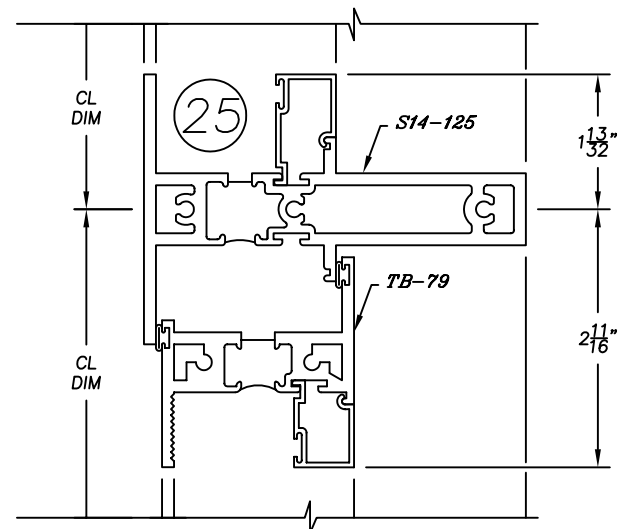
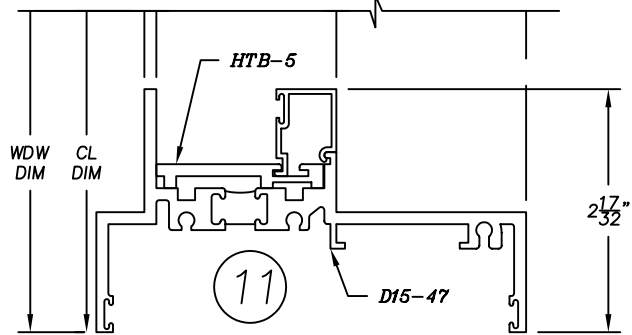
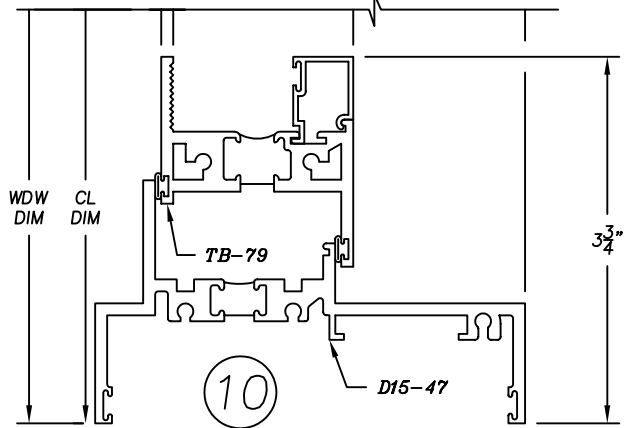
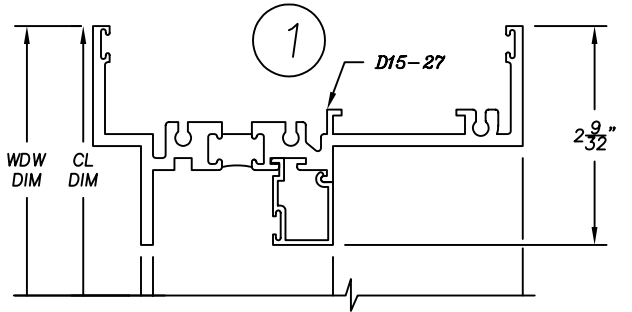
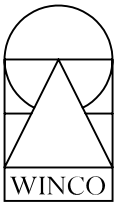

1550H Series

4-1/2" Heavy Commercial
Thermally Improved Window

25

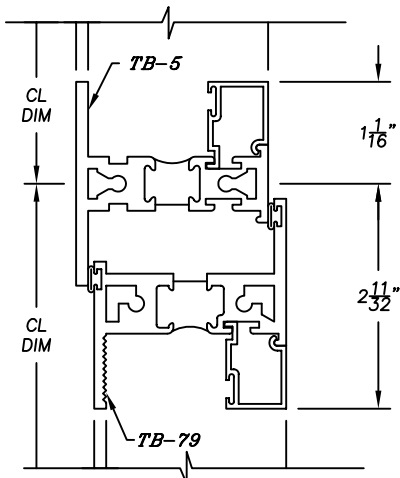

17

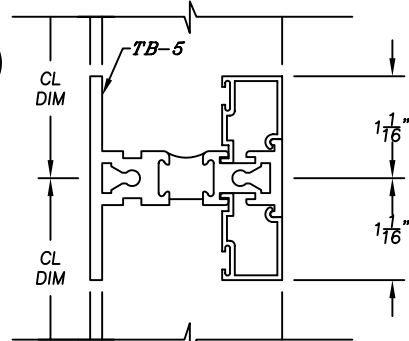

25
HEAVY RAIL

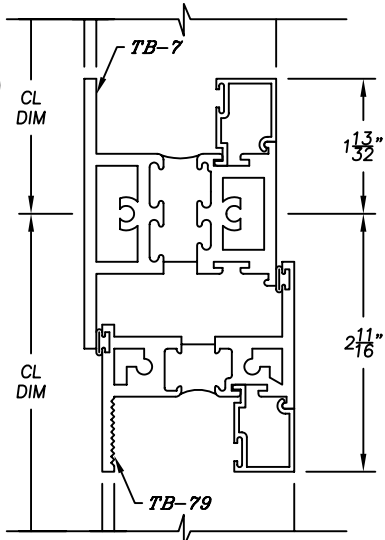

17

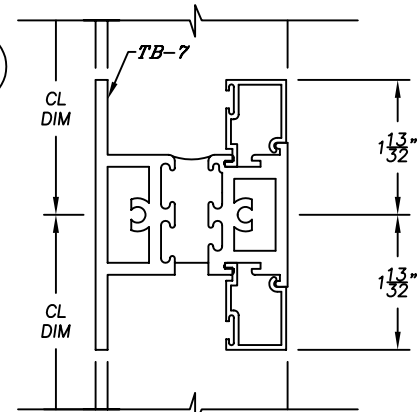

37

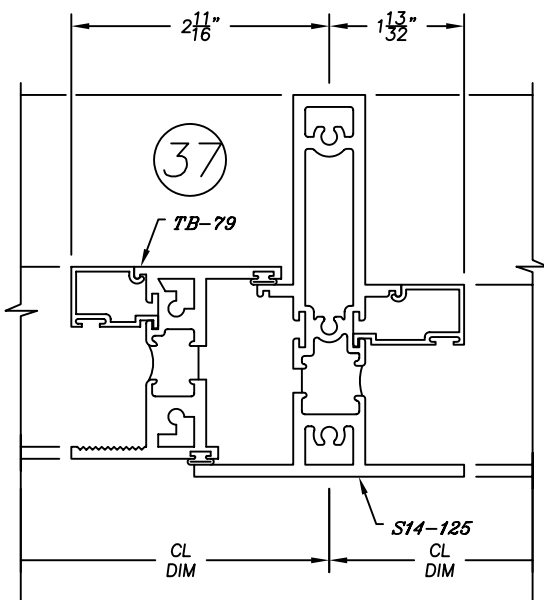
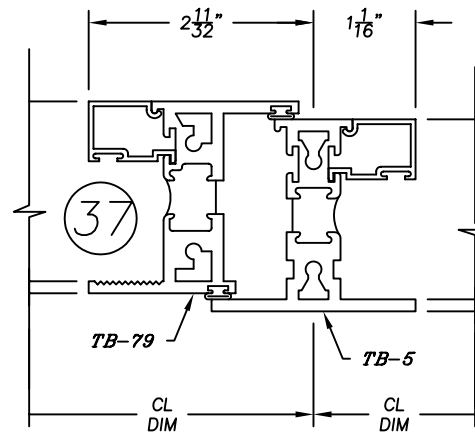

17

