

1565H Series

4-1/2" Heavy Commercial
Thermally Improved Blind Window

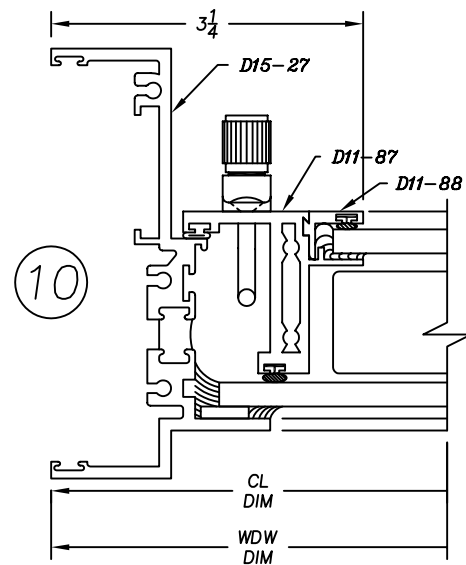

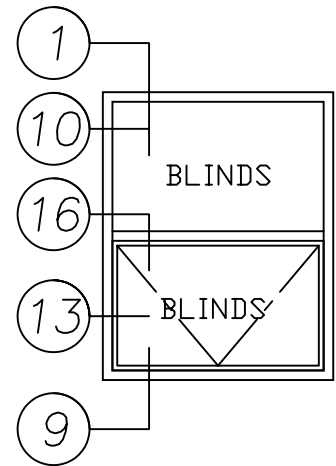
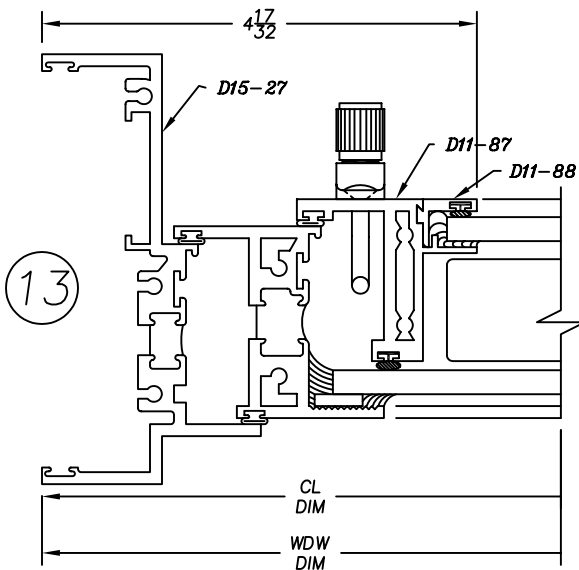
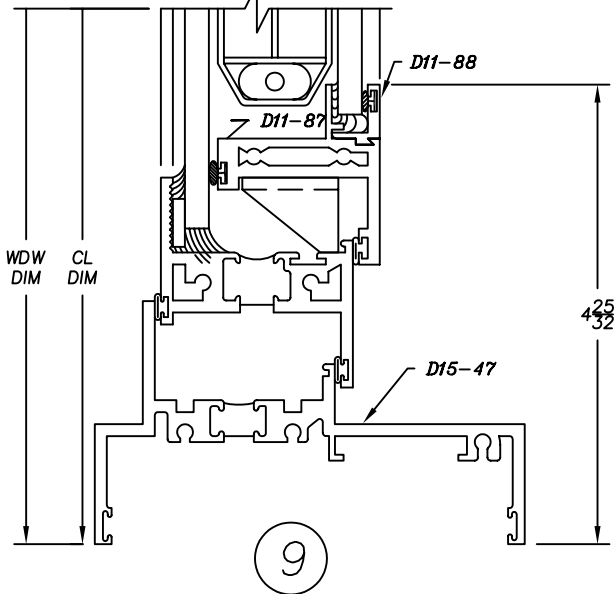
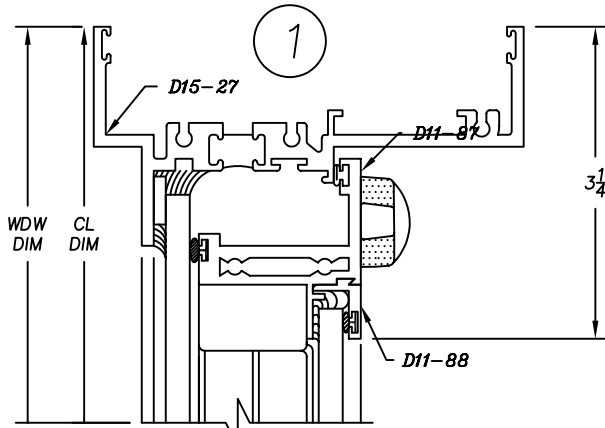
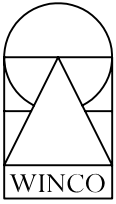

1565H Series

4-1/2" Heavy Commercial
Thermally Improved Blind Window

16

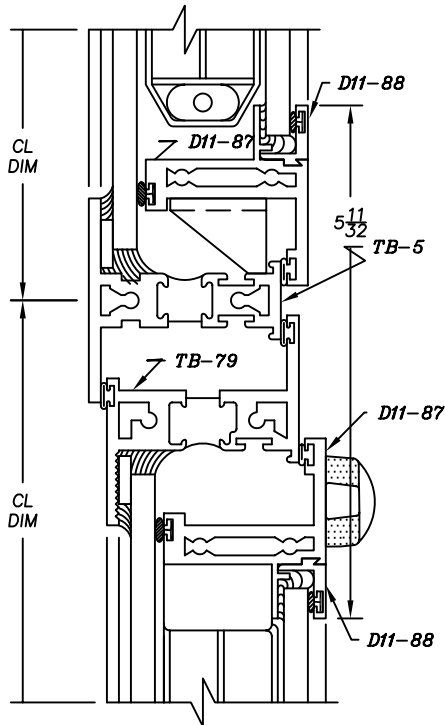

16

HEAVY RAIL

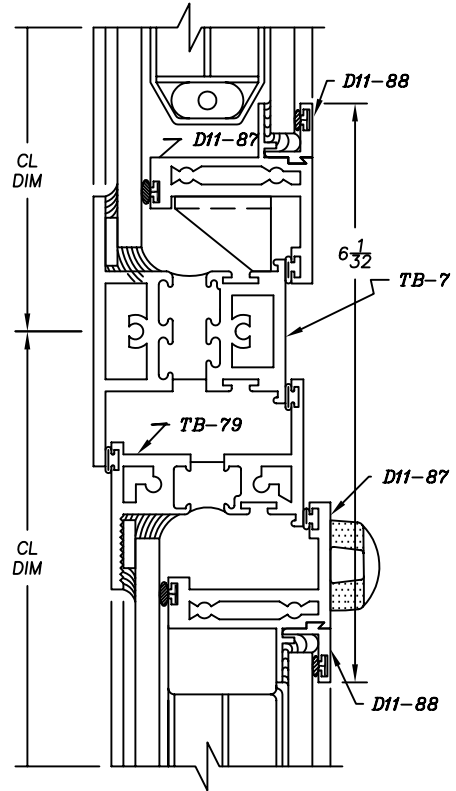

16

