

1565H Series

4-1/2" Heavy Commercial
Thermally Improved Blind Window

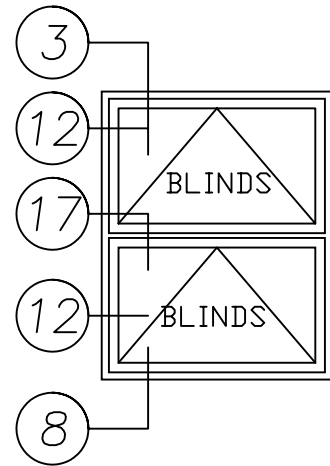

16

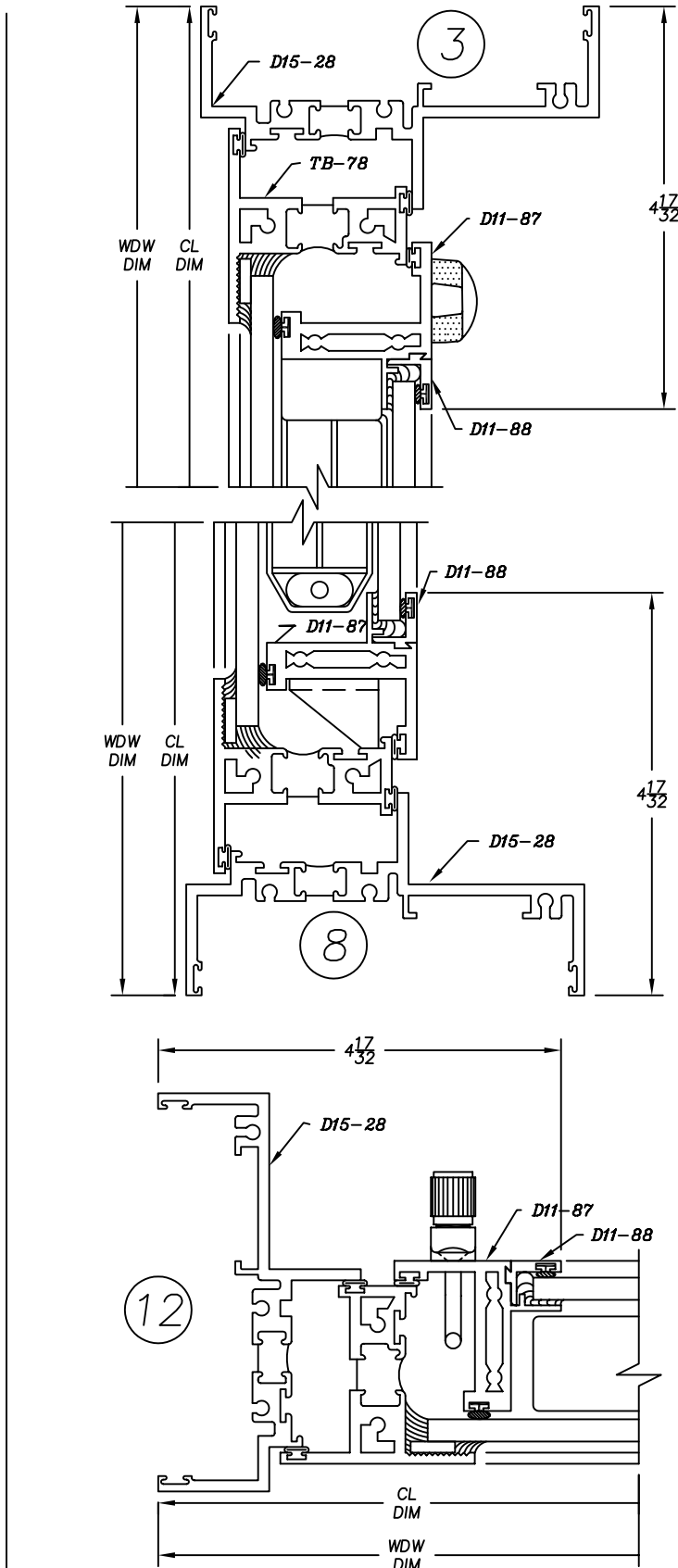
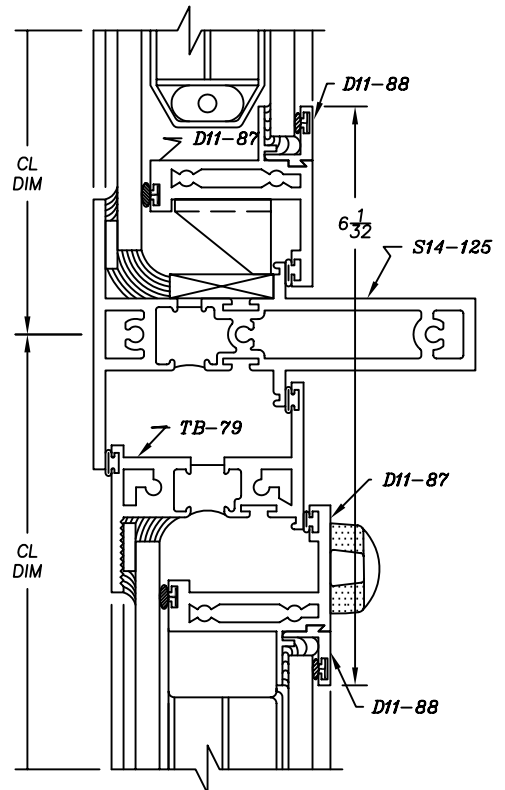

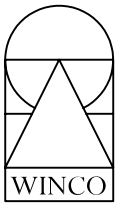

1565H Series

4-1/2" Heavy Commercial
Thermally Improved Blind Window

