

# 1585H Series

4-1/2" Heavy Commercial  
Thermally Improved Blind Window

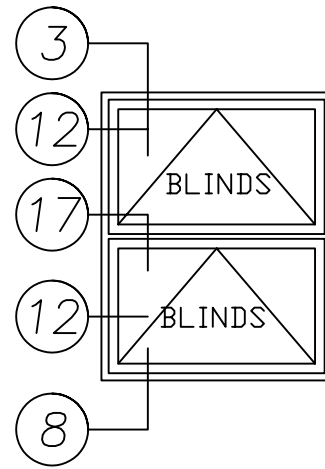

17

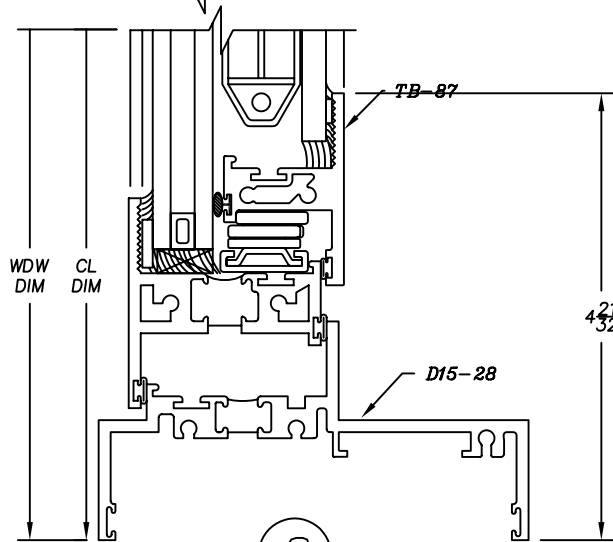
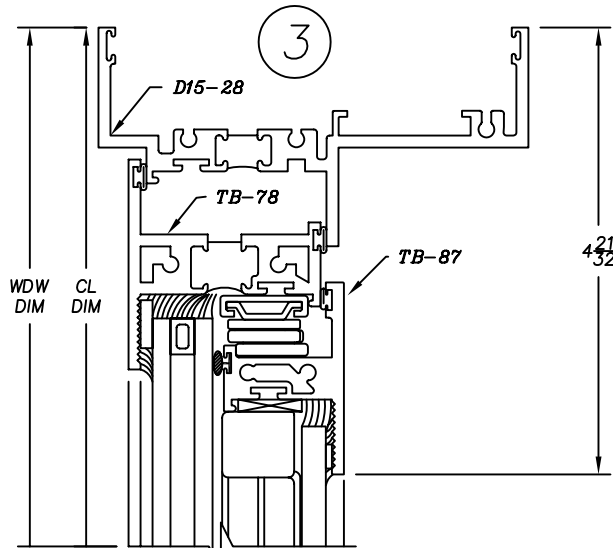
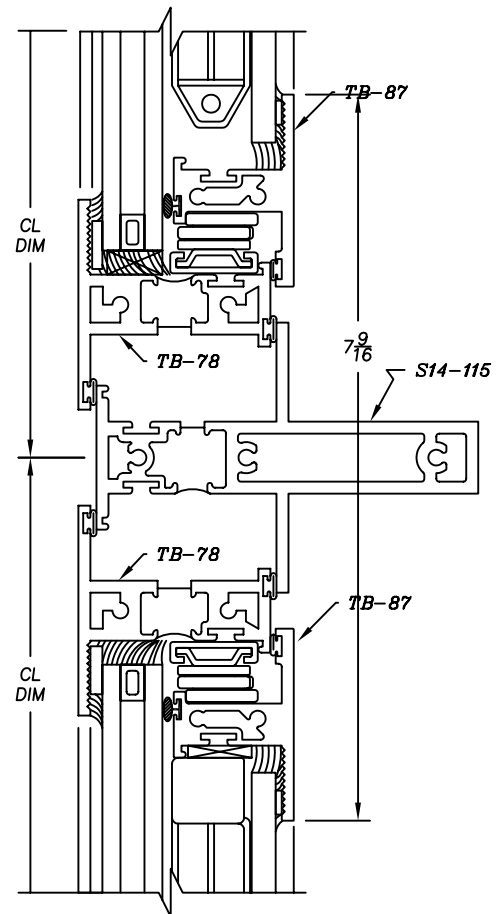

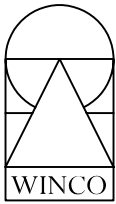

# 1585H Series

4-1/2" Heavy Commercial  
Thermally Improved Blind Window

