

1585H Series

4-1/2" Heavy Commercial
Thermally Improved Blind Window

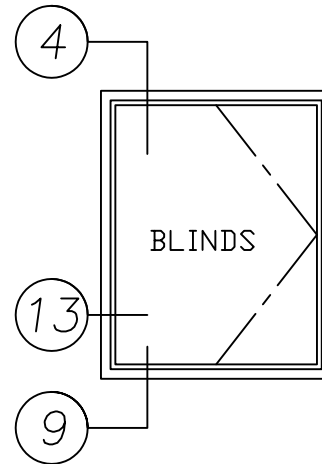

Right Hand In-Swing Casement

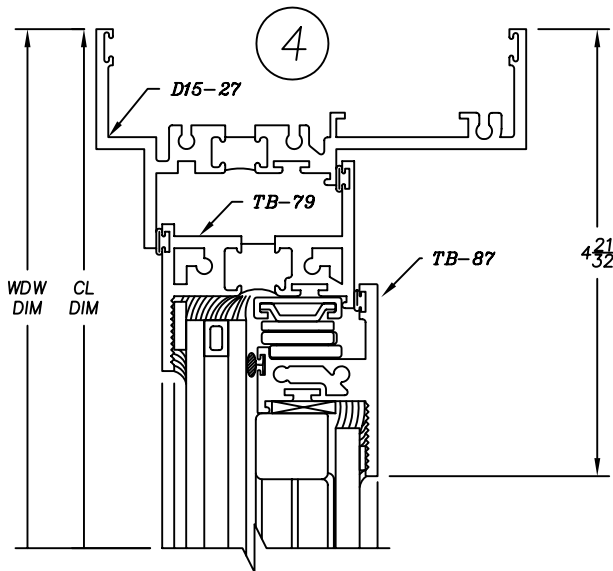