

2265 Series

2" Heavy Commercial
Thermally Improved Blind Window

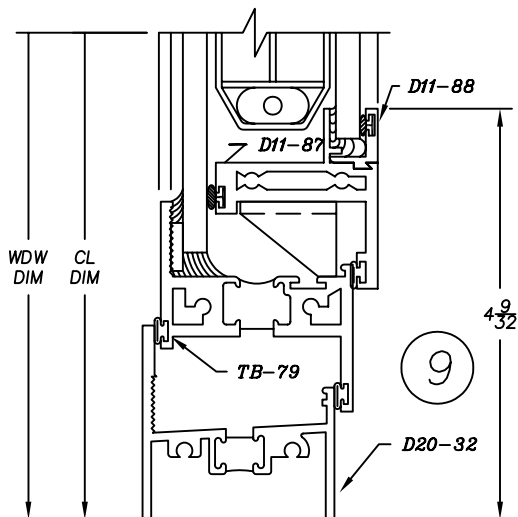

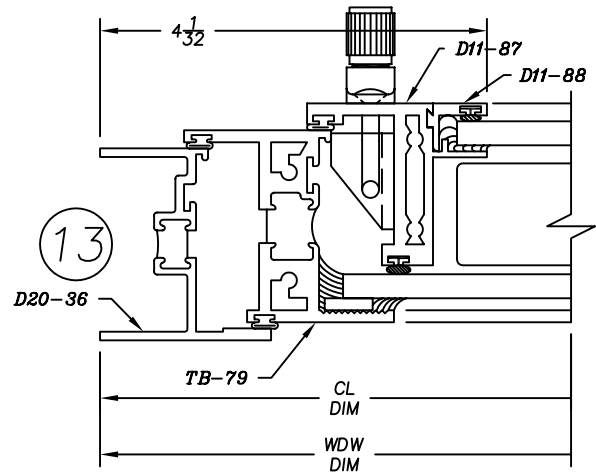
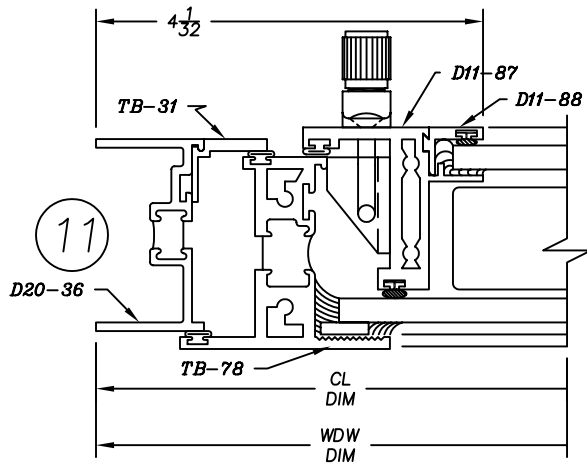
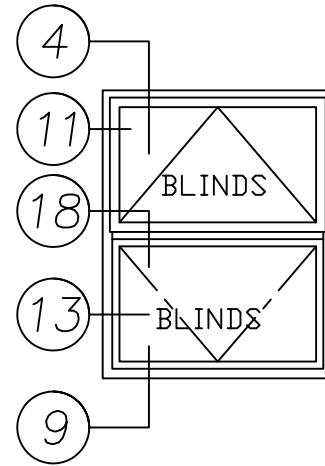
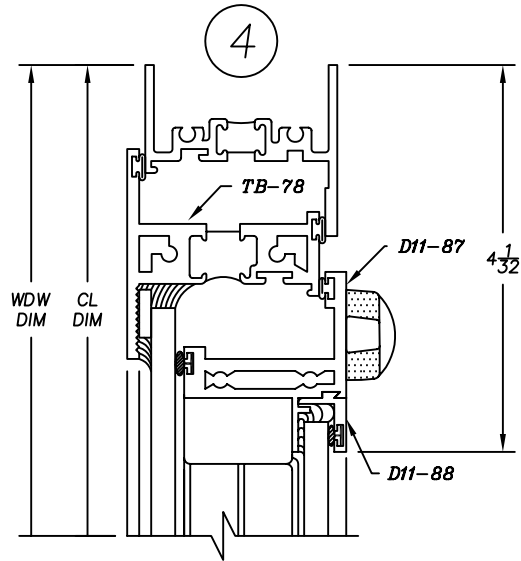
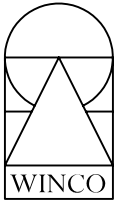

2265 Series

2" Heavy Commercial
Thermally Improved Blind Window

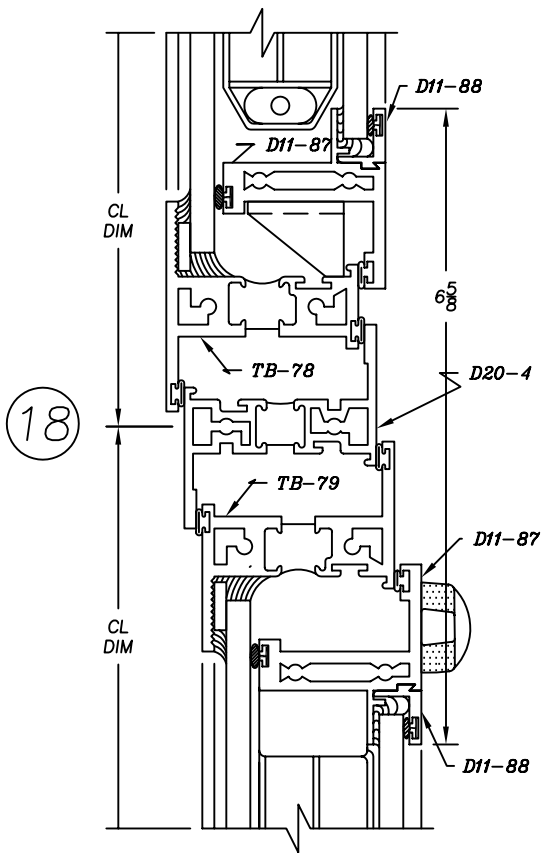

18
HEAVY RAIL

