

1165 Series

2" Heavy Commercial

Thermally Improved Blind Window

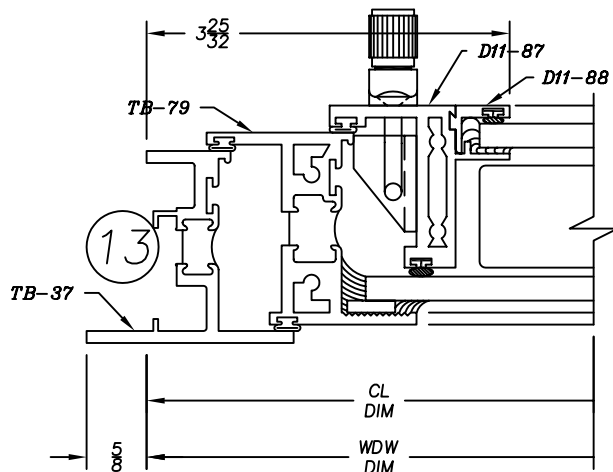

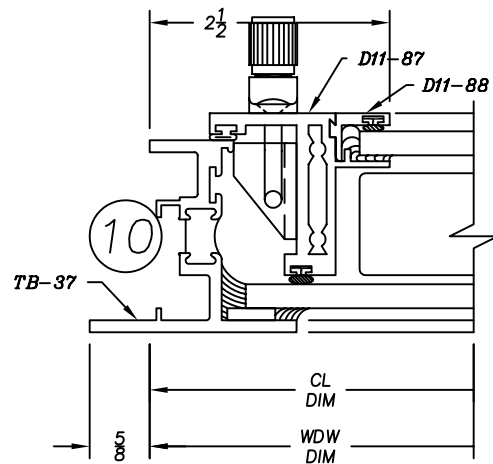
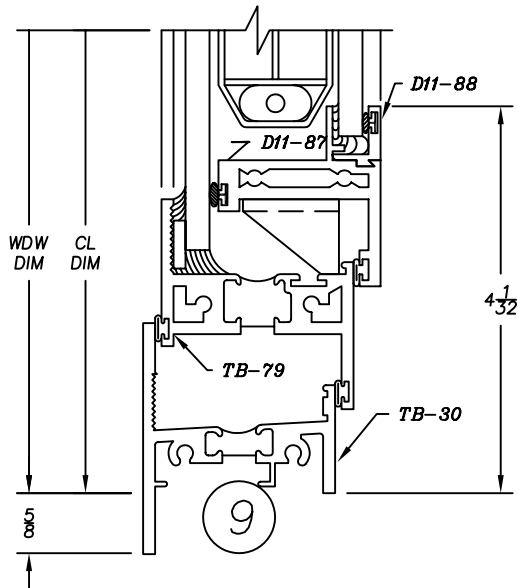
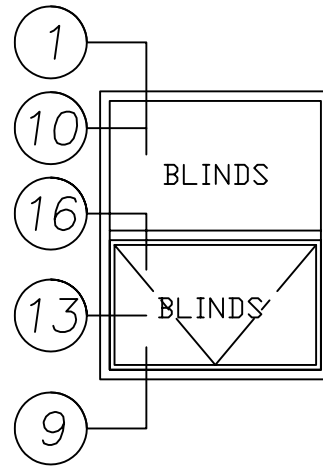
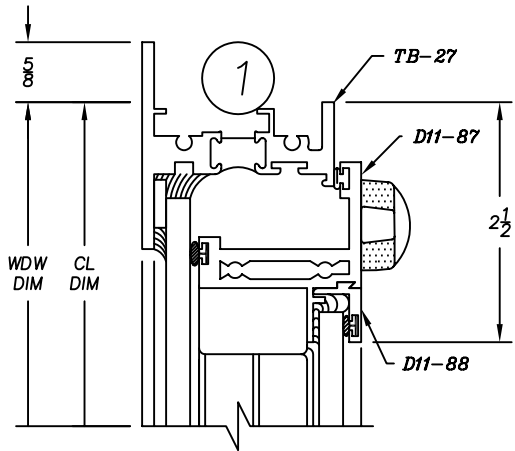
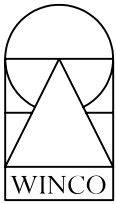

1165 Series

2" Heavy Commercial
Thermally Improved Blind Window

16

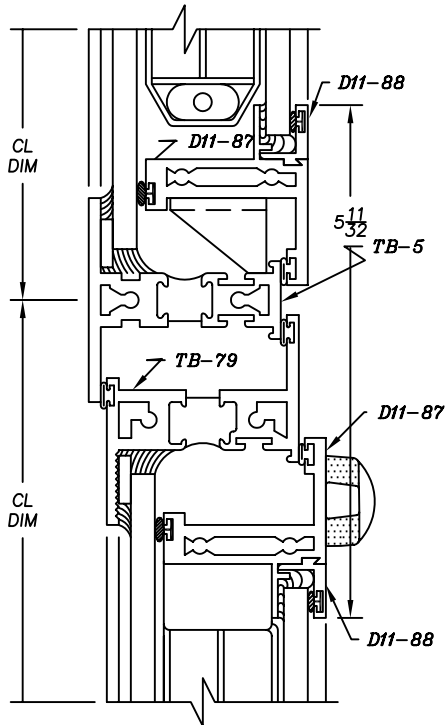

16

HEAVY RAIL

