

# 1165 Series

2" Heavy Commercial  
Thermally Improved Blind Window

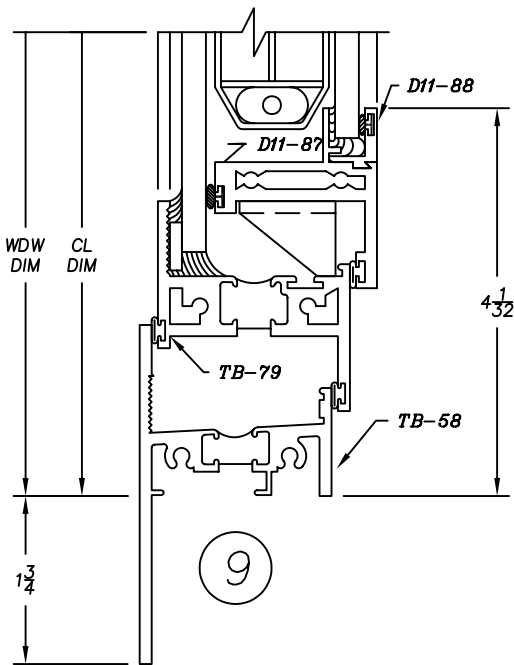

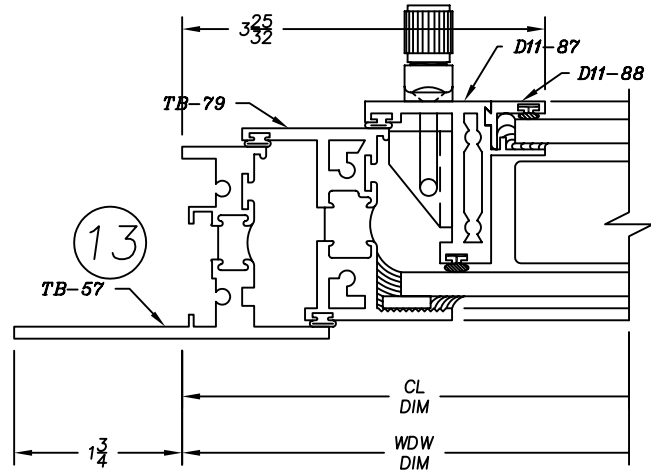
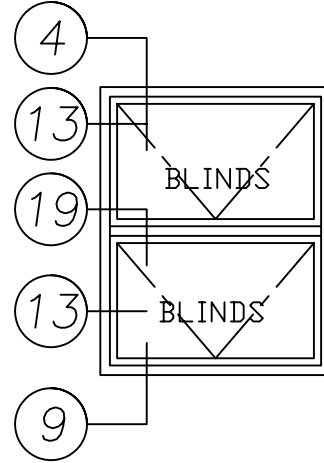
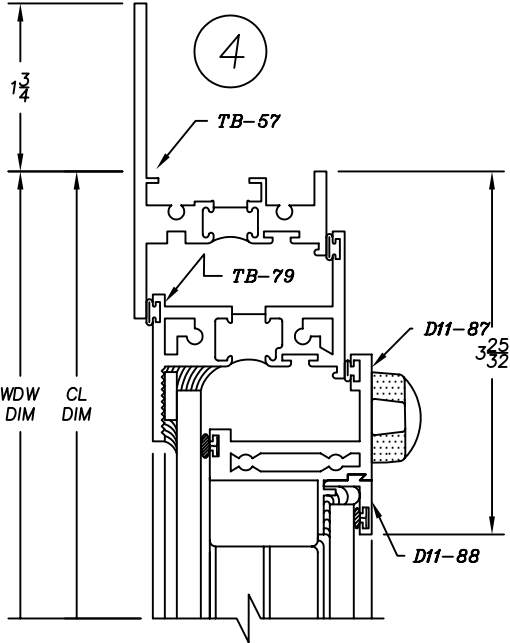
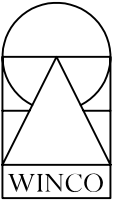

# 1165 Series

2" Heavy Commercial  
Thermally Improved Blind Window

