

1165 Series

2" Heavy Commercial
Thermally Improved Blind Window

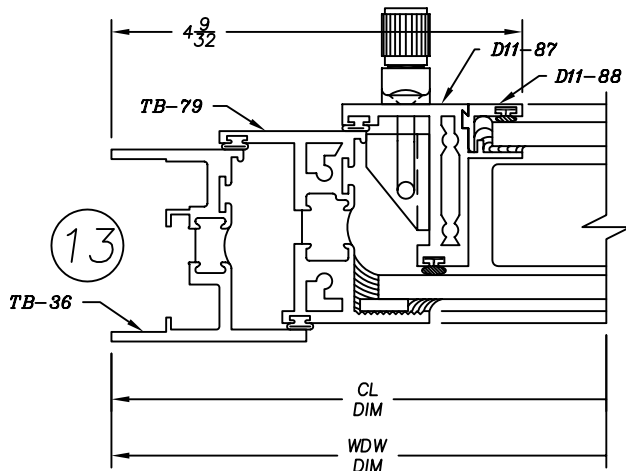

19

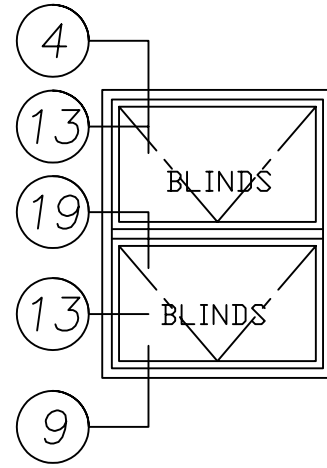
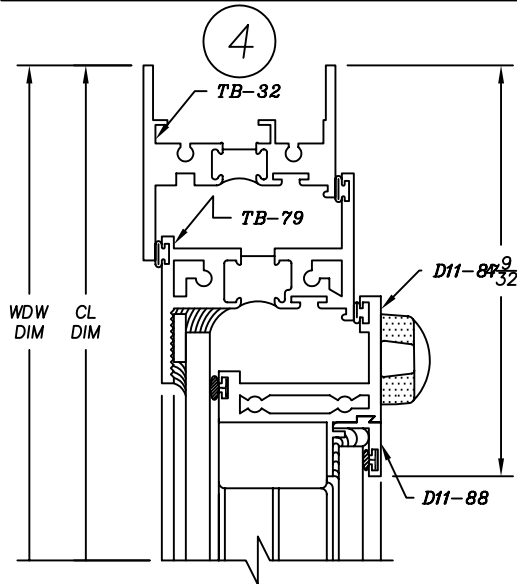