

1175 Series

2" Heavy Commercial

Thermally Improved Blind Window

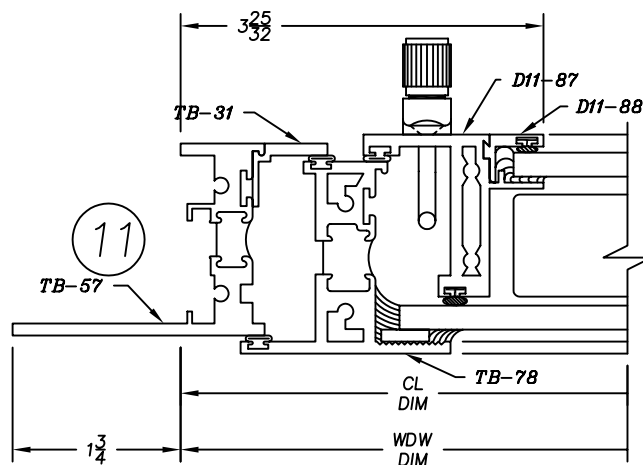

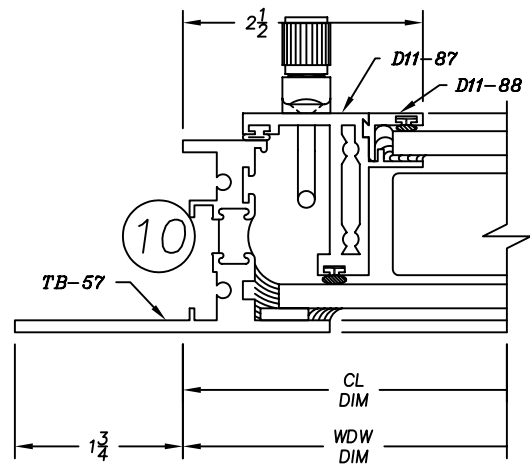
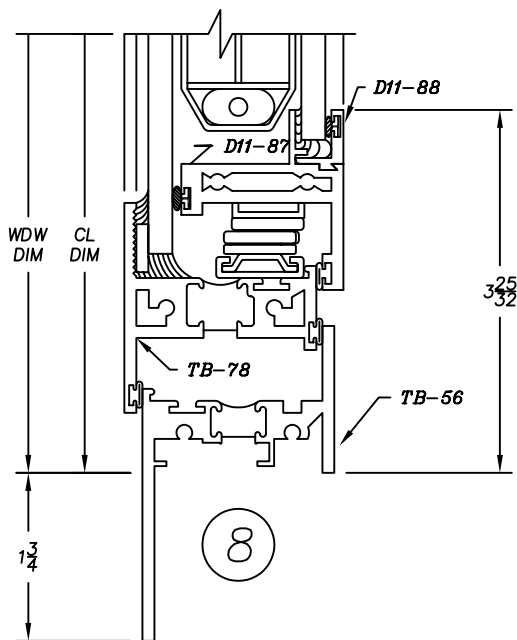
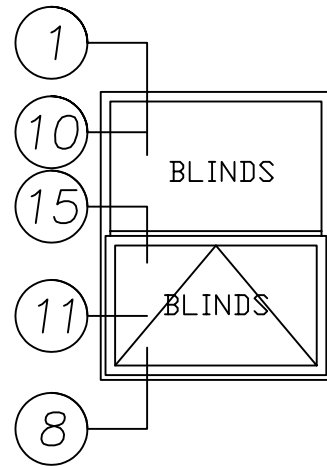
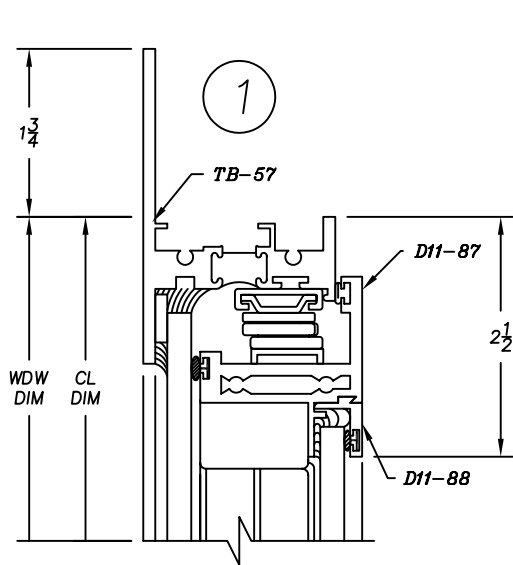
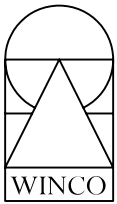

1175 Series

2" Heavy Commercial
Thermally Improved Blind Window

