

1175 Series

2" Heavy Commercial
Thermally Improved Blind Window

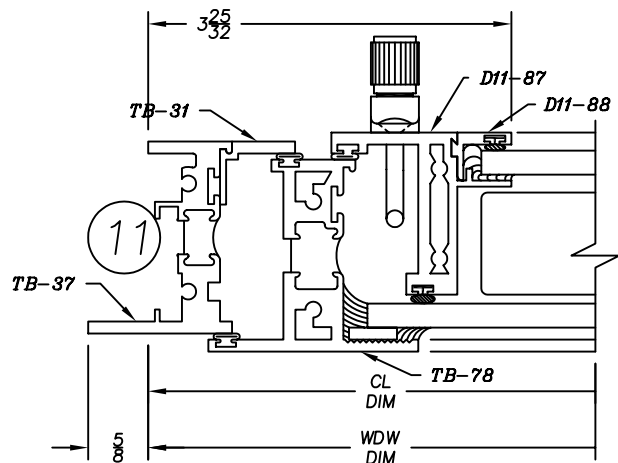

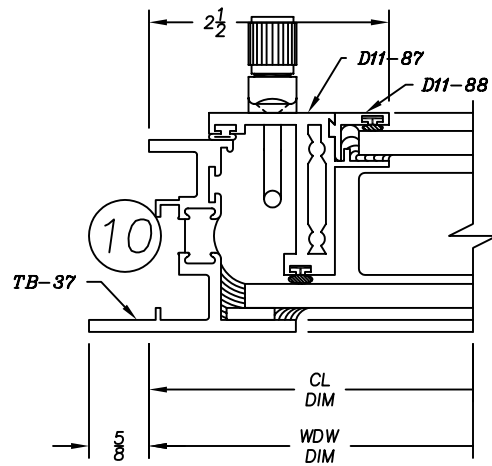
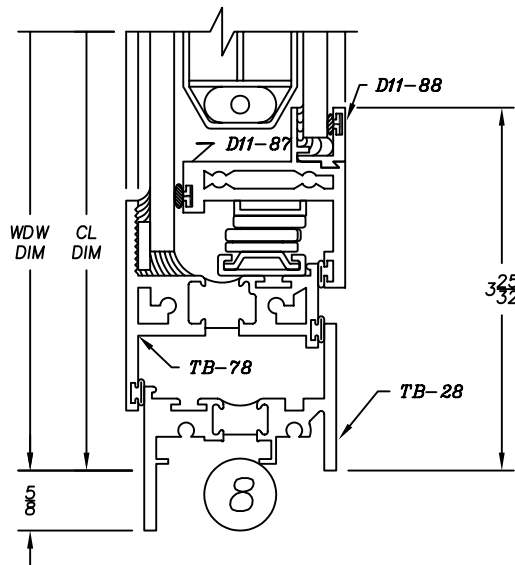
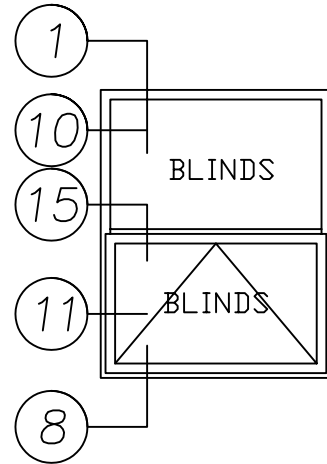
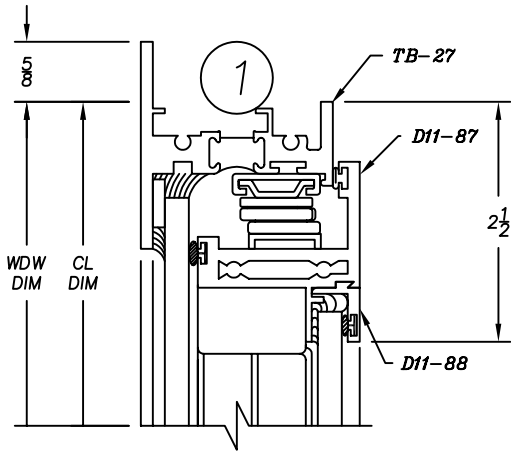
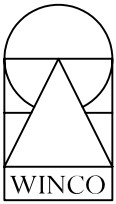

1175 Series

2" Heavy Commercial
Thermally Improved Blind Window

15

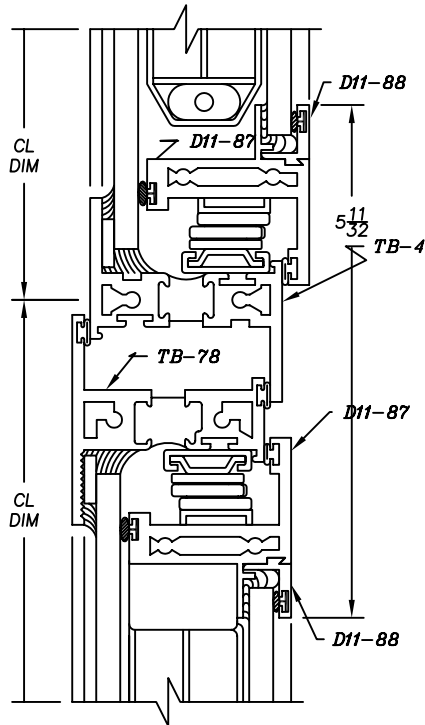

15

HEAVY RAIL

