

1175 Series

2" Heavy Commercial
Thermally Improved Blind Window

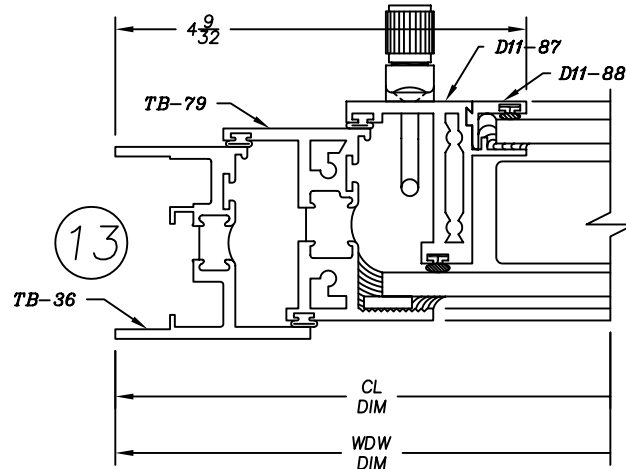

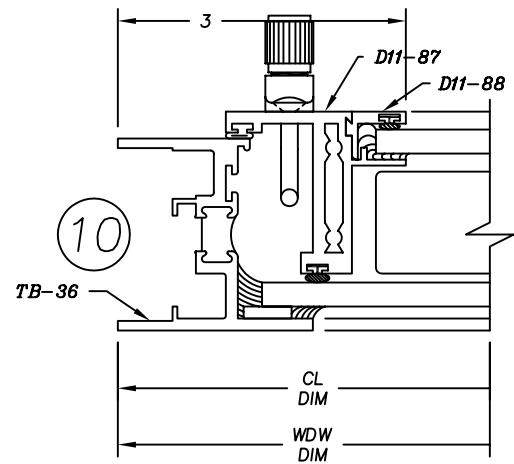
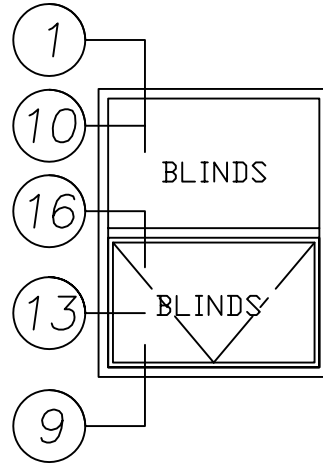
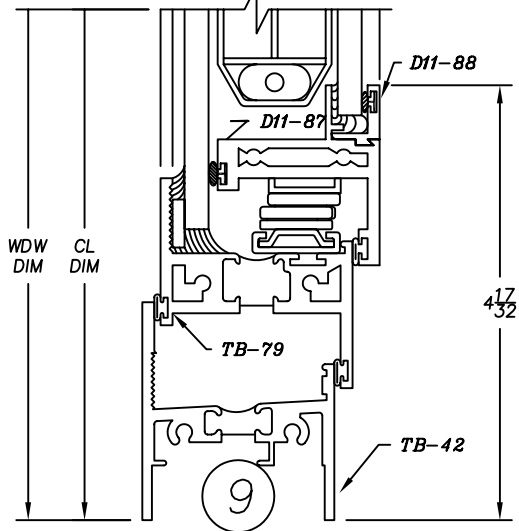
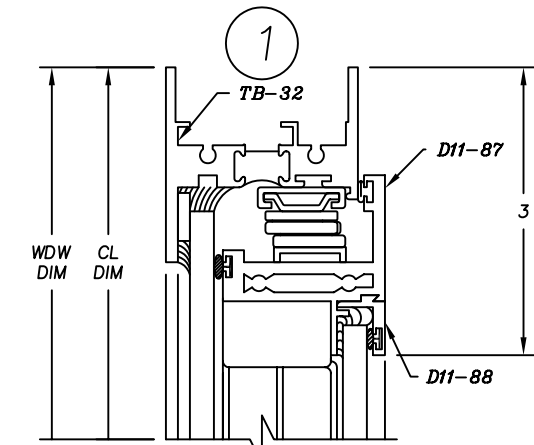
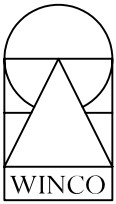

1175 Series

2" Heavy Commercial
Thermally Improved Blind Window

16

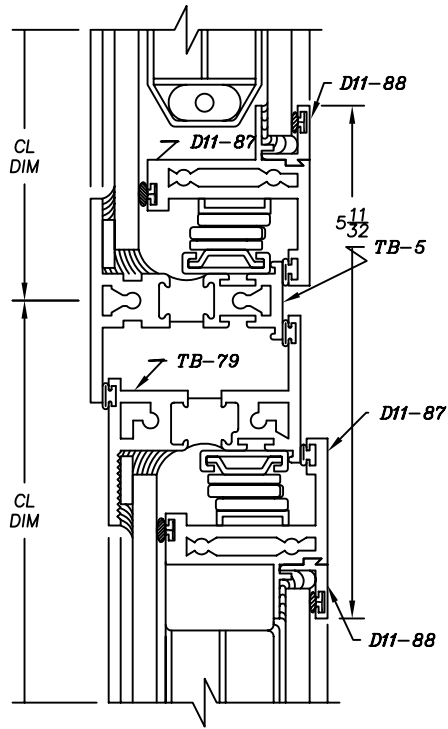

16

HEAVY RAIL

