

# 1175 Series

2" Heavy Commercial

Thermally Improved Blind Window

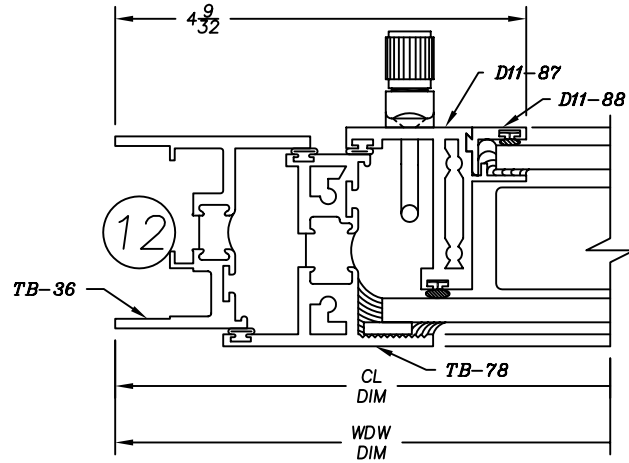

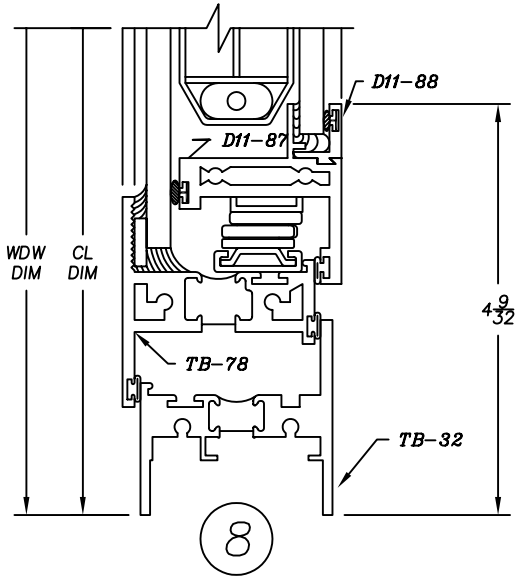
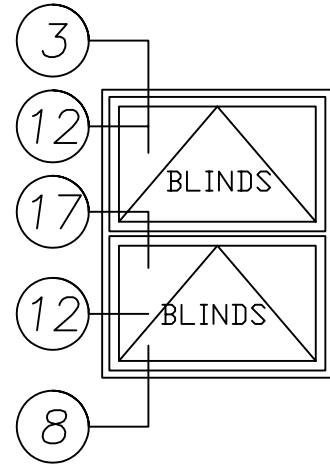
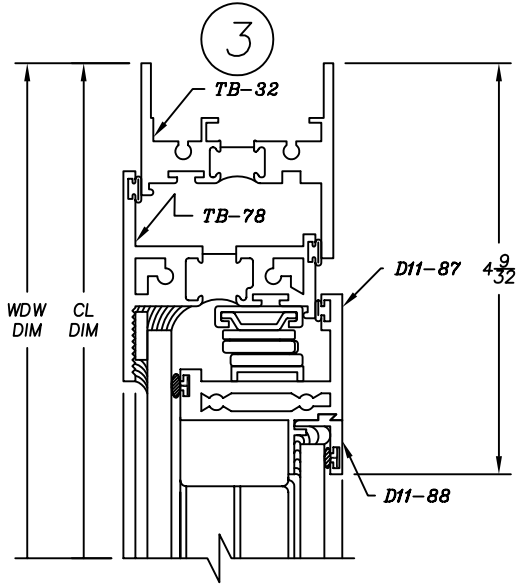
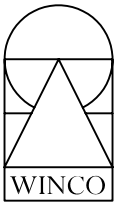

# 1175 Series

2" Heavy Commercial  
Thermally Improved Blind Window

