

2275 Series

2" Heavy Commercial
Thermally Improved Blind Window

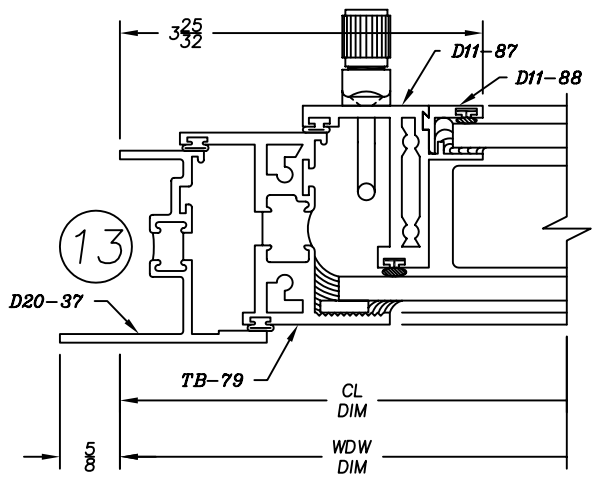

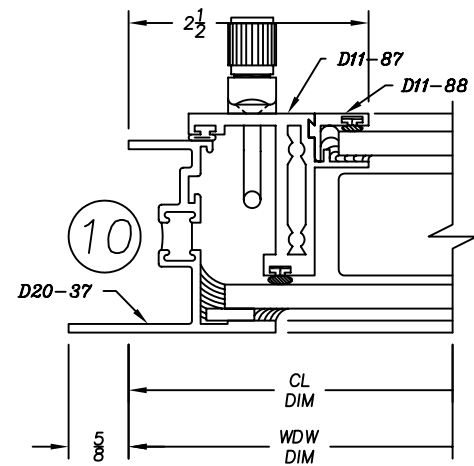
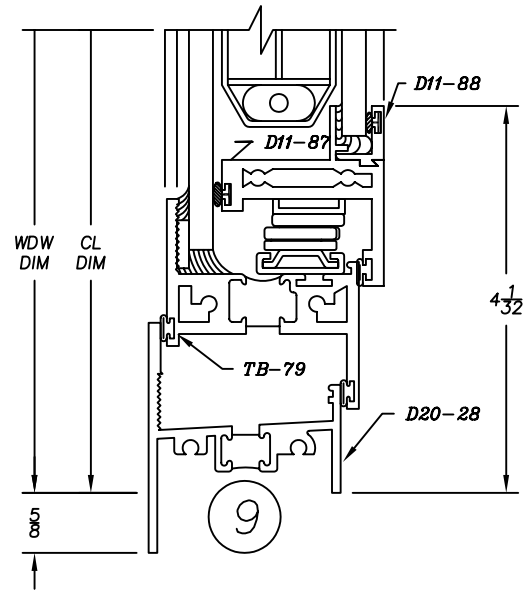
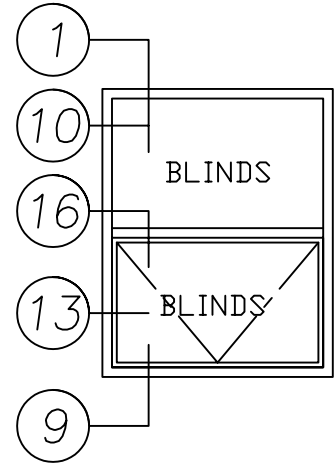
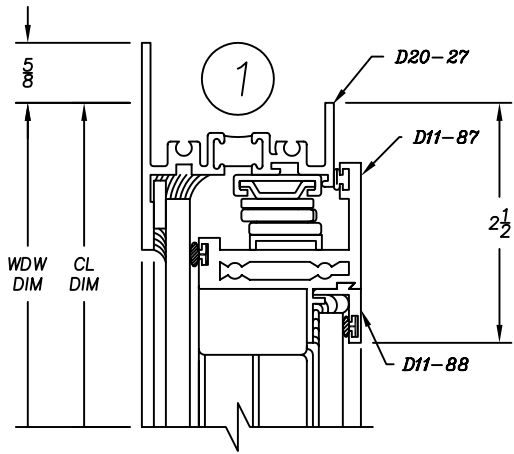
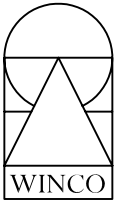

2275 Series

2" Heavy Commercial
Thermally Improved Blind Window

16

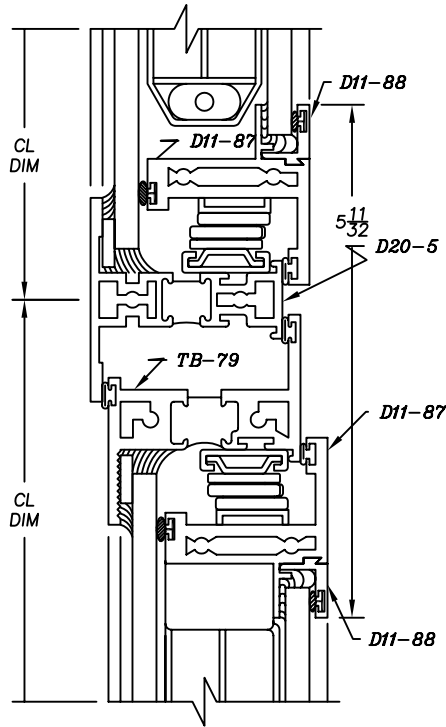

16

HEAVY RAIL

