

2275 Series

2" Heavy Commercial
Thermally Improved Blind Window

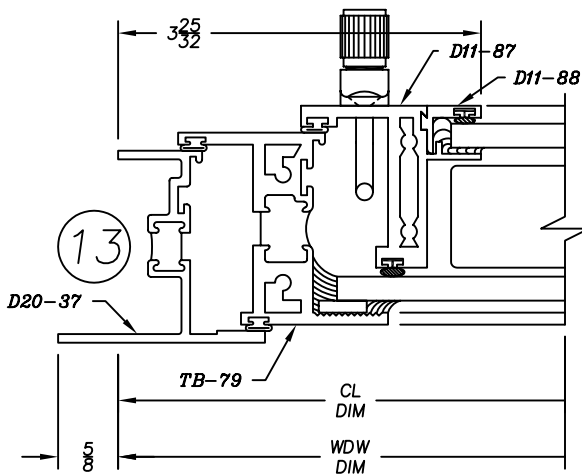

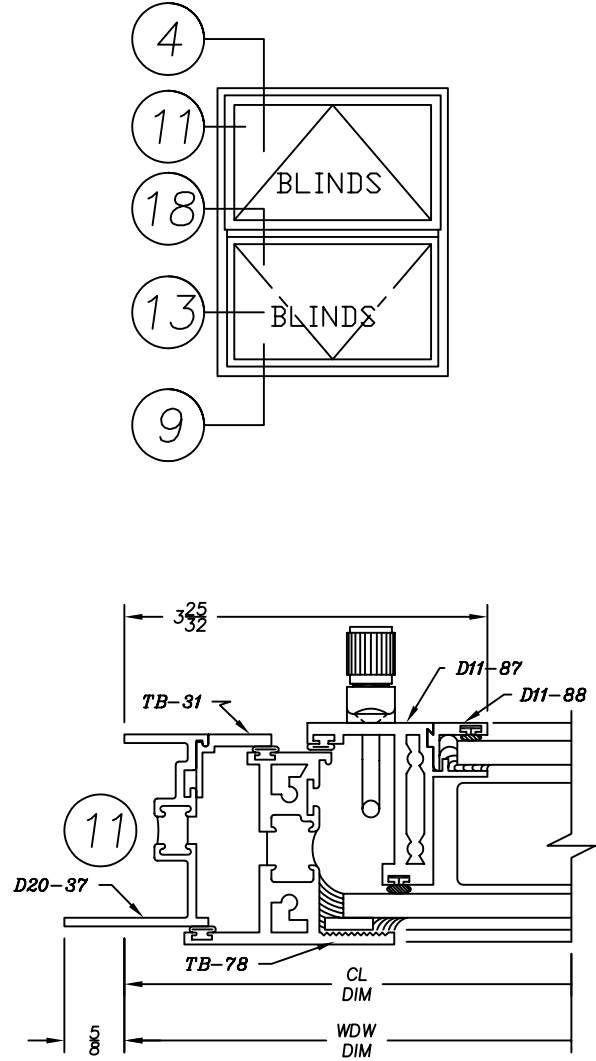
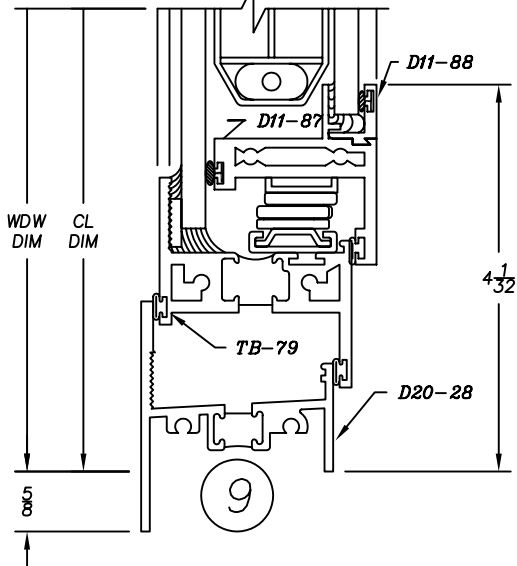
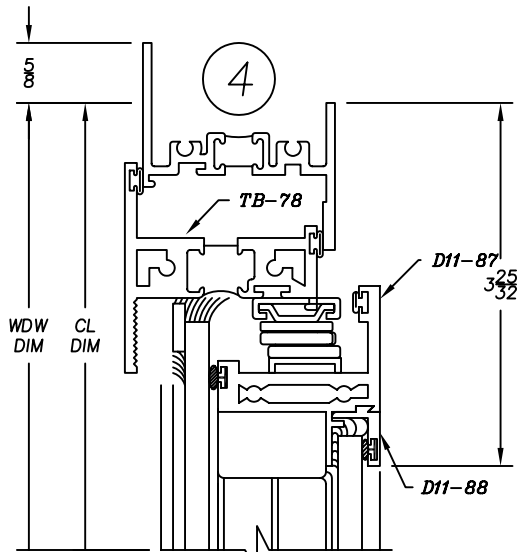
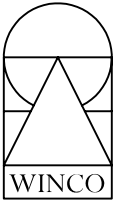

2275 Series

2" Heavy Commercial
Thermally Improved Blind Window

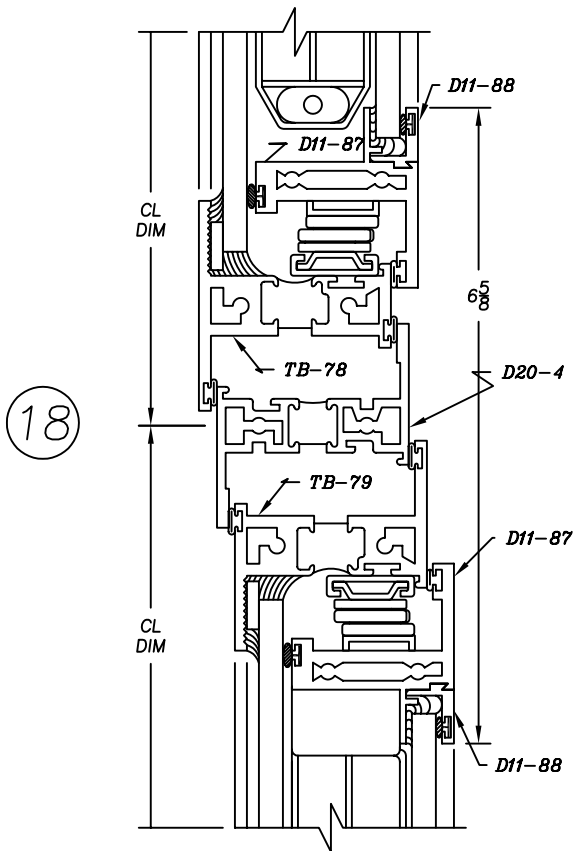

18

HEAVY RAIL

