

2285 Series

2" Heavy Commercial
Thermally Improved Blind Window

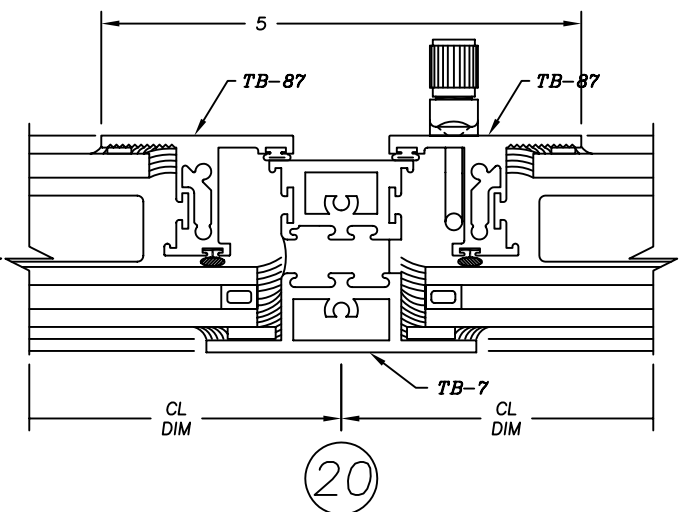

HEAVY RAIL

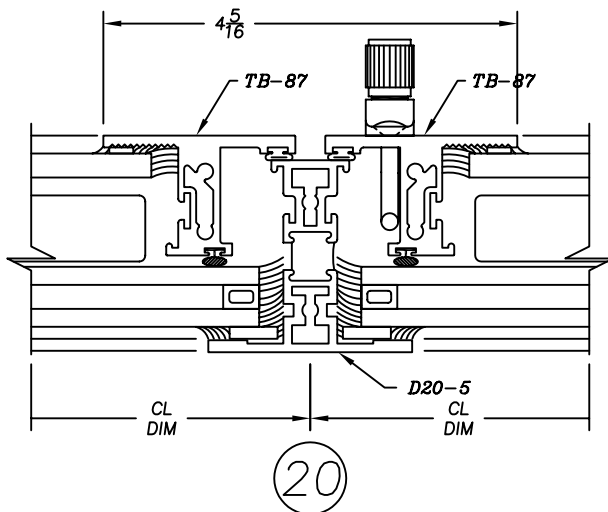
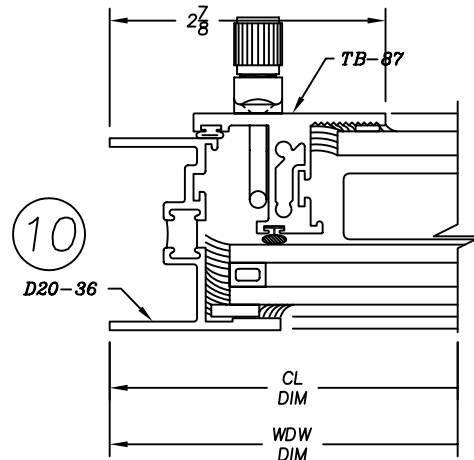
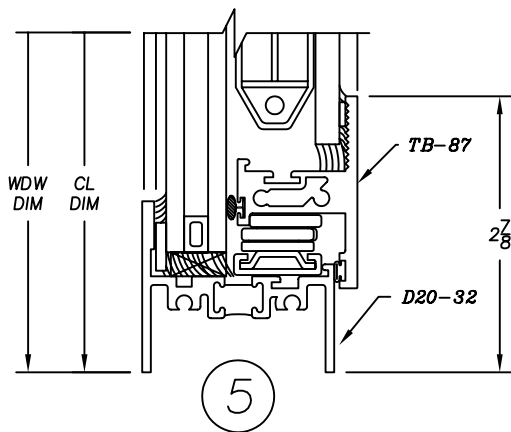
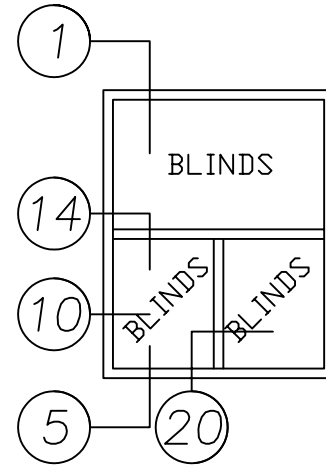
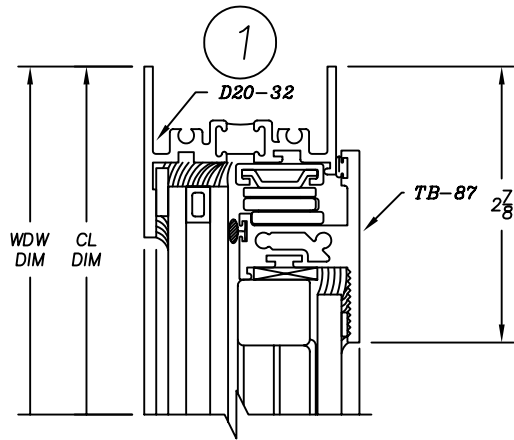
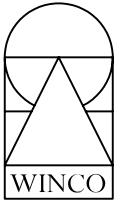

2285 Series

2" Heavy Commercial
Thermally Improved Blind Window

14

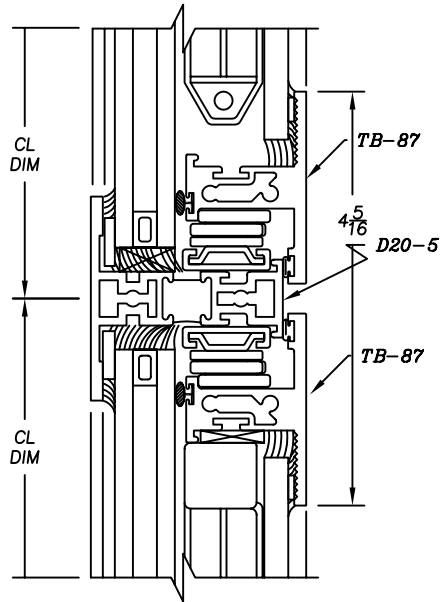

14

HEAVY RAIL

