

3375 Series

3-1/2" Heavy Commercial
Thermally Improved Blind Window

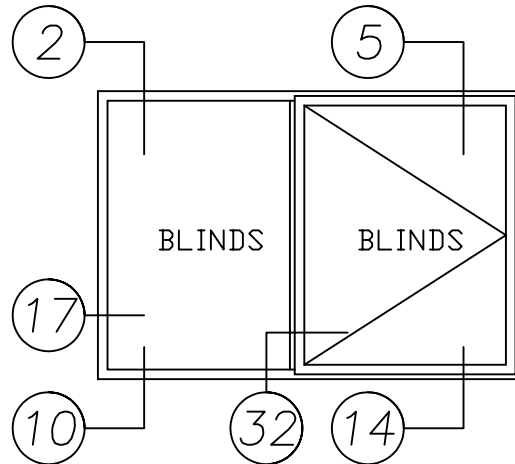

Fixed/Right Hand Out-Swing Casement

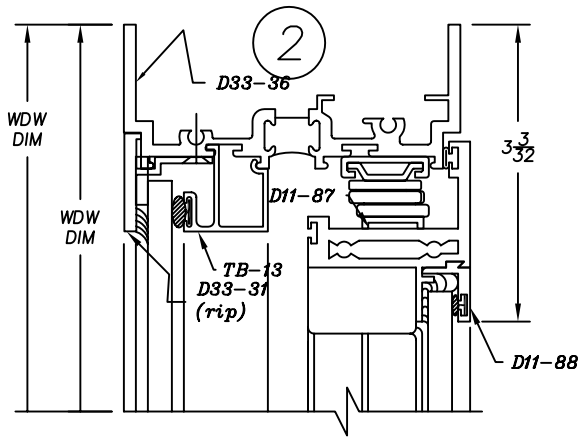
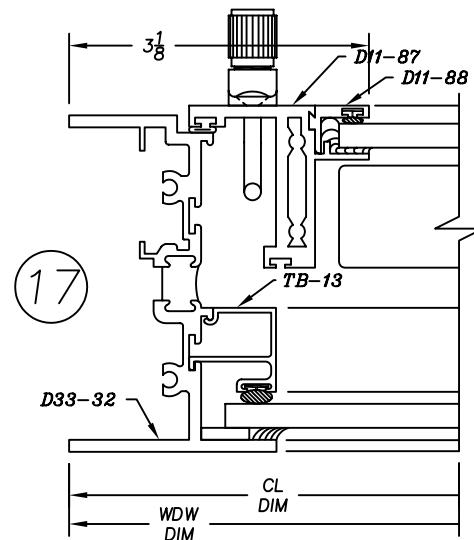
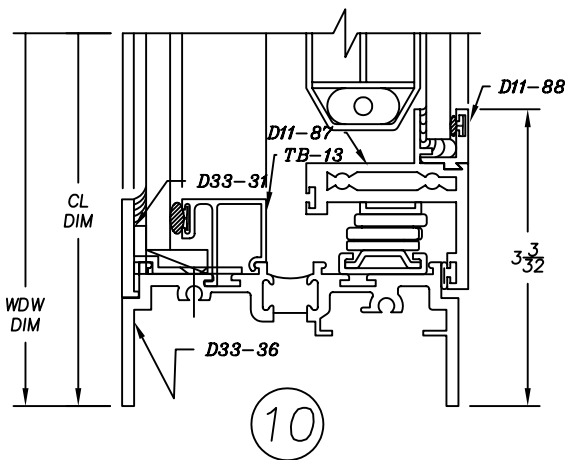
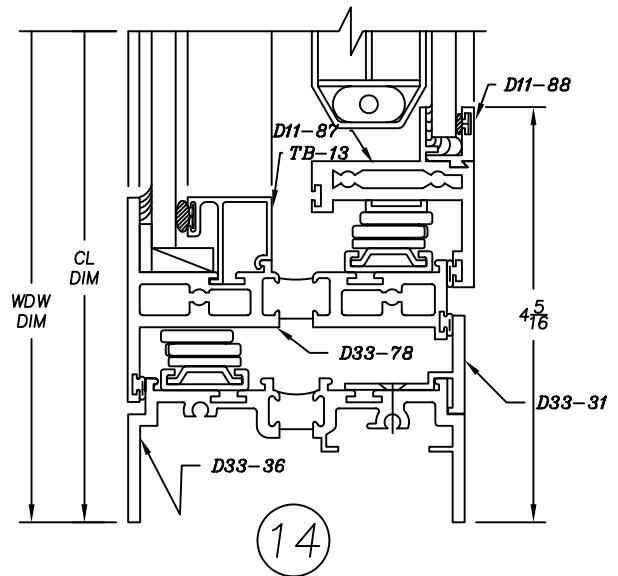
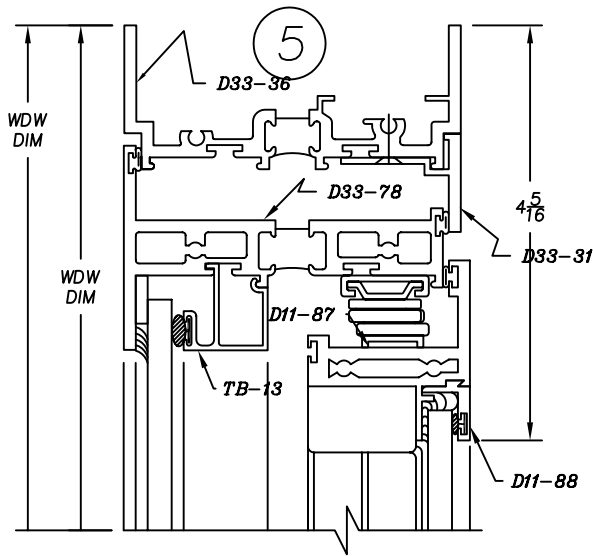

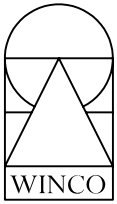

3375 Series

3-1/2" Heavy Commercial
Thermally Improved Blind Window

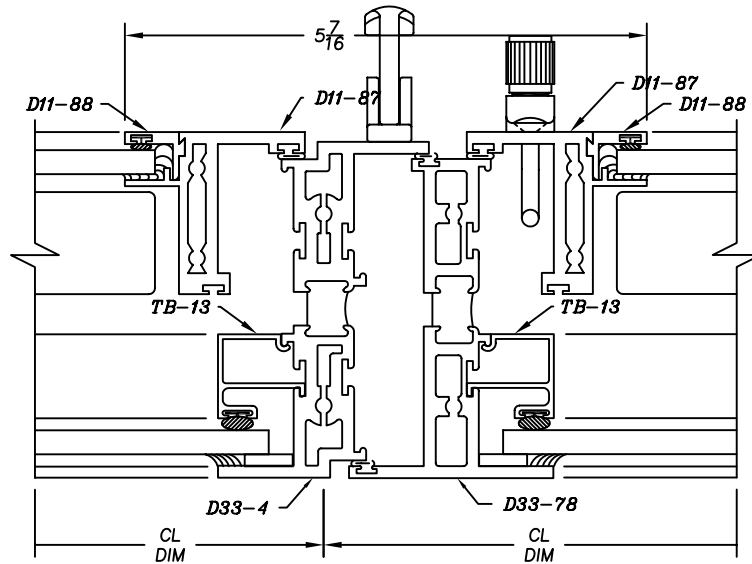

32