

3385 Series

3-1/2" Heavy Commercial
Thermally Improved Blind Window

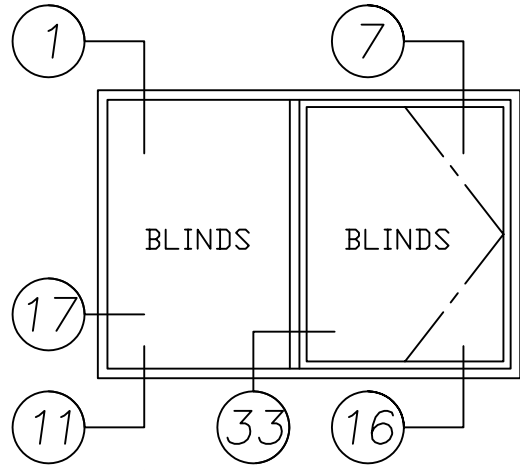

Fixed/Right Hand In-Swing Casement

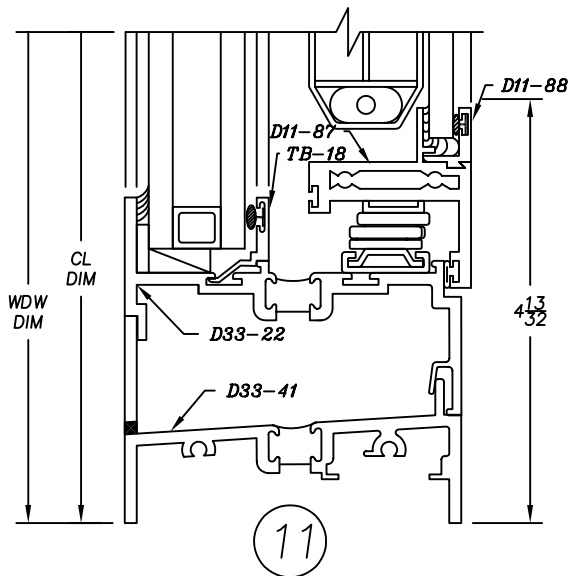
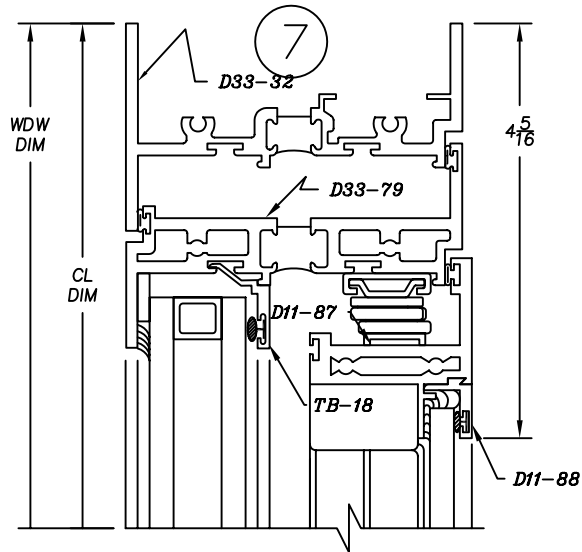
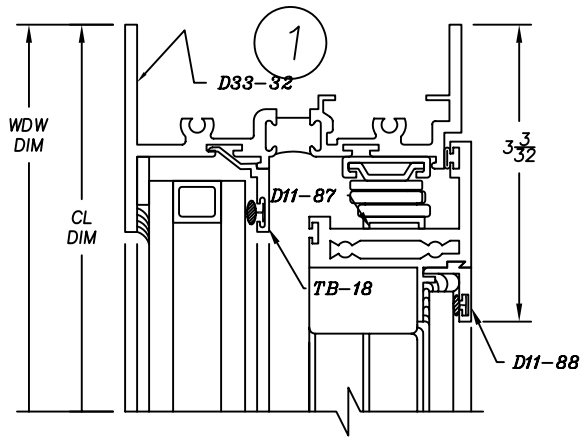
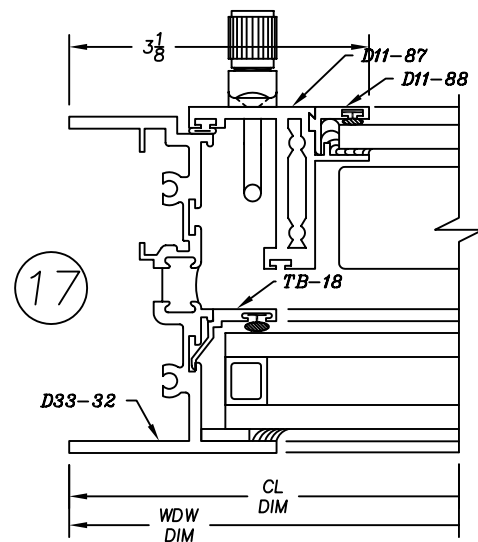
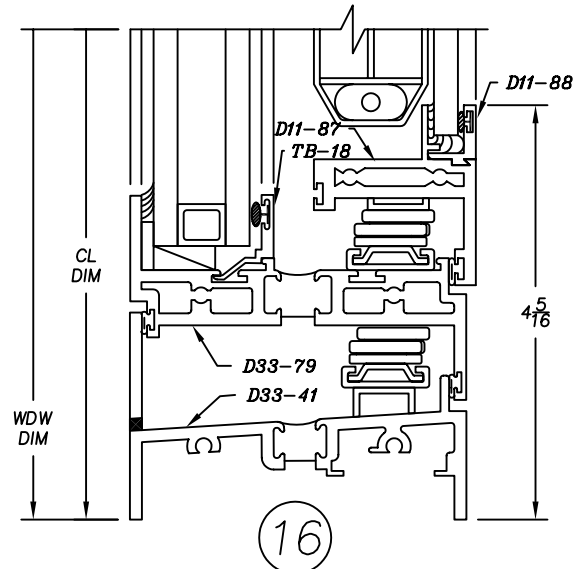

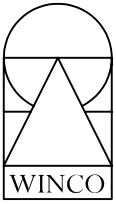

3385 Series

3-1/2" Heavy Commercial
Thermally Improved Blind Window

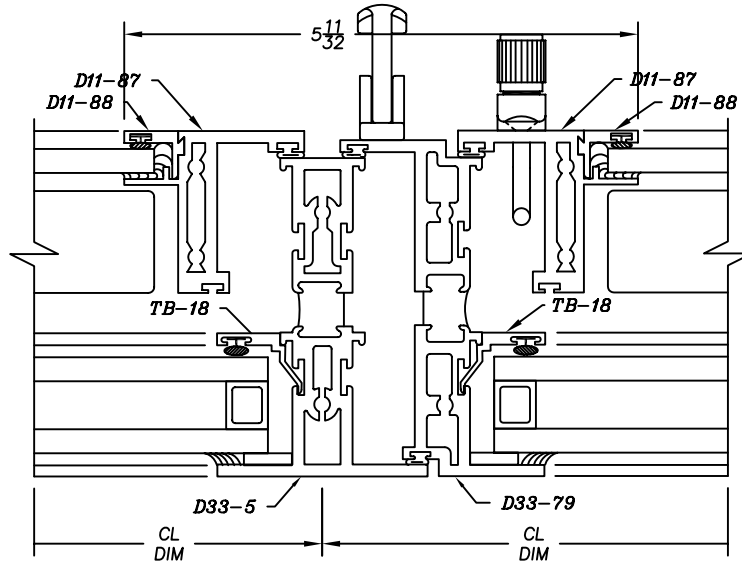

33