

CONSTRUCTION

MATERIAL - The Series 3350 window is a 3-1/2" deep frame depth with a nominal wall thickness of 0.125 inch. All material is extruded from 6063-T6 alloy.

THERMAL BREAK - All framing members of the window system are thermally broken. Winco uses the Azon Azo Brader® process to mechanically condition the surface of the thermal cavity. The process runs the entire length of the extrusion and creates serrations that insure proper adhesion of the structural polymer. The structural urethane is a high density 2 part formula providing optimum thermal performance for the most demanding conditions. The combination of the conditioning of the aluminum surface along with the two part urethane allows Winco to provide a full 10 year warranty against thermal break creep and shrinkage in accordance with AAMA 505-98.

FABRICATION - The main frame corners are coped and mechanically joined using two stainless steel spline screws per corner (fig 1). All frame joints are back sealed with small joint seam sealer providing a water tight joinery.

WINCO RESERVES THE RIGHT TO MODIFY OR CHANGE INFORMATION WITHIN
THIS BOOK WHEN DEEMED NECESSARY FOR PRODUCT IMPROVEMENT

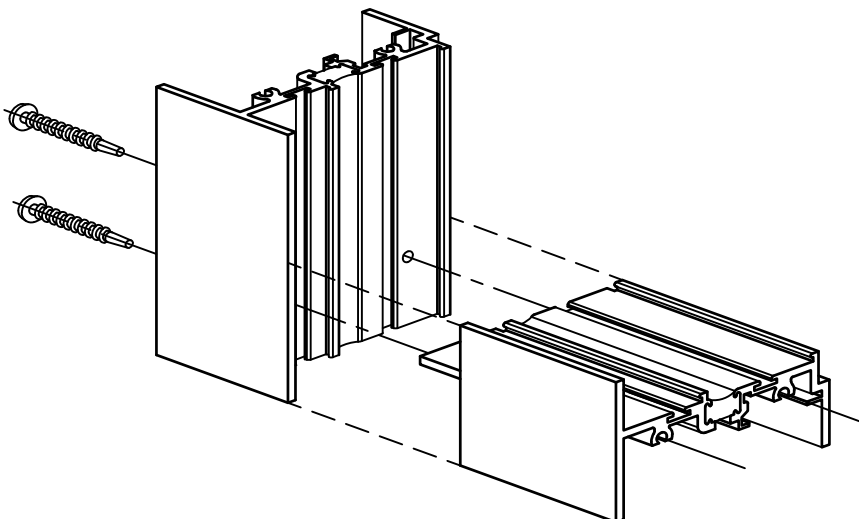

(fig 1) Main Frame Construction

© WINCO WINDOW COMPANY, INC. 2021