



# Series 3250 Steel Replica

3-1/4" Architectural Grade Thermal Window System  
Fixed - Projected - Casement



## Product Overview

Winco's 3250 Steel Replica window series was designed to satisfy historic requirements while also meeting modern building codes demands. With the thinnest profiles on the market for an architectural grade, thermal window system the 3250 is still robust and versatile successful in large openings and achieving low U-Values.

In addition, the 3250 meets coastal hurricane zone requirements while preserving the architectural integrity of significant historic buildings.

Green Commitment

Energy Savings

Noise Control

Blast Shield

Historic Replication

Wind Protection

## Features & Custom Options

- Azon "Azo-Brader" thermally broken frame and sash, backed by a 10 year warranty against thermal break shrinkage
- Integral extruded beveled glazing leg
- Vertical and horizontal stacking members
- Vent can be suspended in the middle of a fixed window
- Optional aluminum extruded screens
- Accessory line of receptors, mullions, panning and trim for a customized look
- Blast, ballistic and impact glazing available

## Performance Data\*

Type	Air (CFM/FT2 @ 6.24 PSF)	Water (PSF)	Structural (PSF)	CRF	U-Value (Btu/Hr-Ft <sup>2</sup> -°F)	STC
Fixed AW Grade AW-120	Less than 0.10	12 (Higher levels may be available upon request)	+/- 180	63*	0.27*	Contact your local Rep
Projected AW Grade AP-AW80	Less than 0.10	12 (Higher levels may be available upon request)	+/- 120	59*	0.36*	

\*U-Value, CRF, Water and AW ratings are based on a particular type of glazing and window configuration being used. They are provided for comparison purposes only. They are based on products of standard configuration, tested in accordance with NFRC/FGIA/AAMA specifications, in a laboratory environment under optimum conditions. Performance values will vary according to project specifications, installation, size, configuration, hardware, glass, etc. Any required field testing should be done in accordance with the project specifications and FGIA/AAMA field testing protocol, not this data.



# Series 3250 Steel Replica Detail Drawings

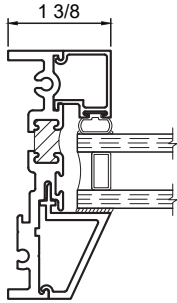
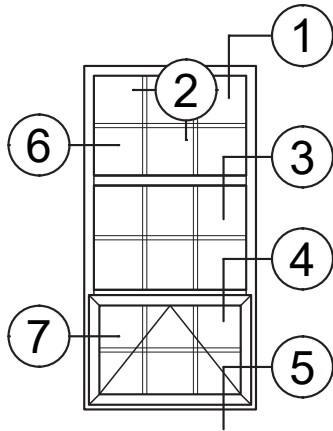

6

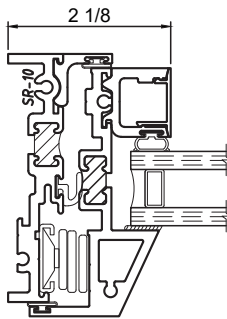

7

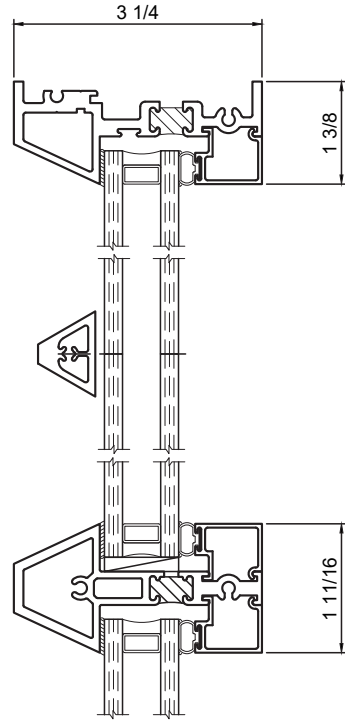

1

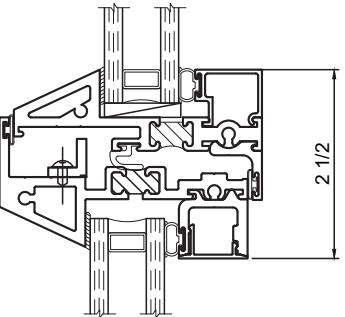

2

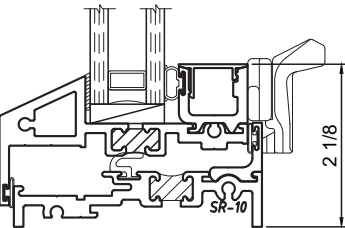

3

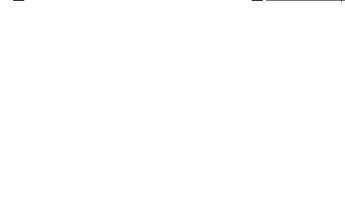

4



5



Winco Window Company  
6200 Maple Avenue  
St Louis, MO 63130

TESTING: Our products meet stringent testing requirements of both the American Architectural Manufacturers Association (AAMA) and the National Fenestration Rating Council (NFRC) standards and certification.

