

CONSTRUCTION

MATERIAL - The Series 3350 window is a 3-1/2" deep frame depth with a nominal wall thickness of .125 inch. All material is extruded from 6063-T6 alloy.

THERMAL BREAK - All framing members of the window system are thermally broken. Winco uses the Azon Azo Brader® process to mechanically condition the surface of the thermal cavity. The process runs the entire length of the extrusion and creates serrations that ensure proper adhesion of the structural polymer. The structural urethane is a high density 2 part formula providing optimum thermal performance for the most demanding conditions. The combination of the conditioning of the aluminum surface along with the two part urethane allows Winco to provide a full 10 year warranty against thermal break creep and shrinkage in accordance with AAMA 505-17.

WEATHER-STRIP - All operating ventilators have a double Santoprene®, non-shrinking dual durometer, thermoplastic rubber weather-stripping around the perimeter. One interior and one exterior.

FABRICATION - The main frame corners are coped and mechanically joined using two stainless steel spline screws per corner (fig 1). The vent is a hollow tube shaped extrusion for superior strength and rigidity. Vent corners are fully mitered and mechanically joined using two stainless steel spline screws per corner, aligning the members to form a hairline joint (fig 2). All frame joints are back sealed with small joint seam sealer providing a water tight joinery.

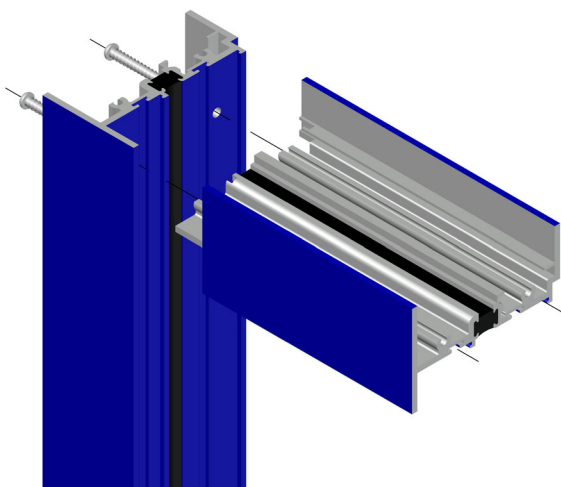

(fig 1) Main Frame Construction

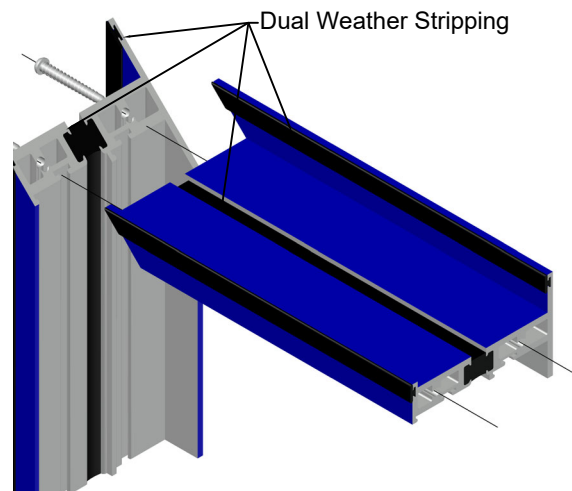

(fig 2) Vent Construction