

3350 Series 3-1/2" Thermal Fixed, Casement & Projected Windows

Product Information - Glass Options & Combination



GLAZING

The windows can be interior or exterior glazed with .050 thick extruded aluminum glazing beads accommodating thicknesses from 1/4" up to 1 1/2". Dual or triple glazing is an option utilizing an interior panel sash that can either be hinged with 4-bar stainless steel hinges or a more economical take out sash. Venetian blinds are available with the dual or triple glazed window options. See the quick reference chart below for all glazing options. For actual details refer to the glazing section in the back of the 3350 section for optional glazing and blind details.

WINCO RESERVES THE RIGHT TO MODIFY OR CHANGE INFORMATION WITHIN THIS BOOK WHEN DEEMED NECESSARY FOR PRODUCT IMPROVEMENT

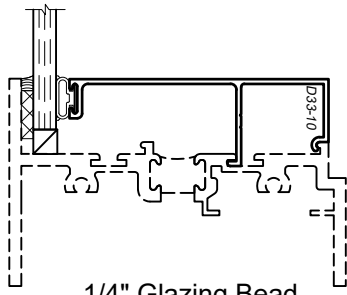

1/4" Glazing Bead
D33-10

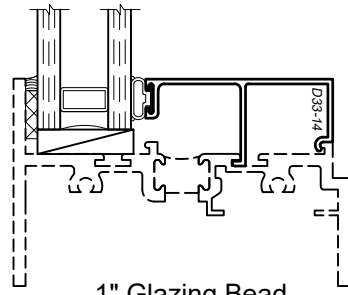

1" Glazing Bead
D33-14

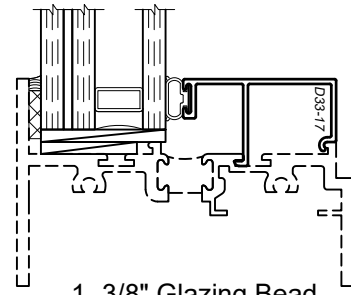

1- 3/8" Glazing Bead
D33-17

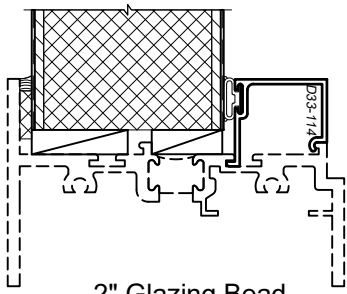

2" Glazing Bead
D33-114

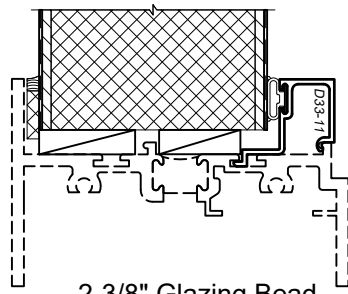

2-3/8" Glazing Bead
D33-11

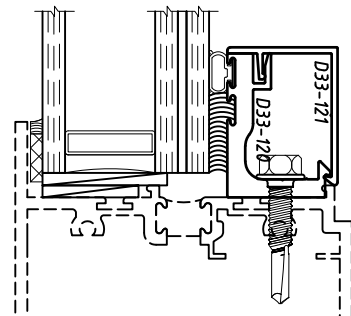

1-3/4" Glazing Bead
D33-120 / D33-121
(limited use only)

Frame Inserts

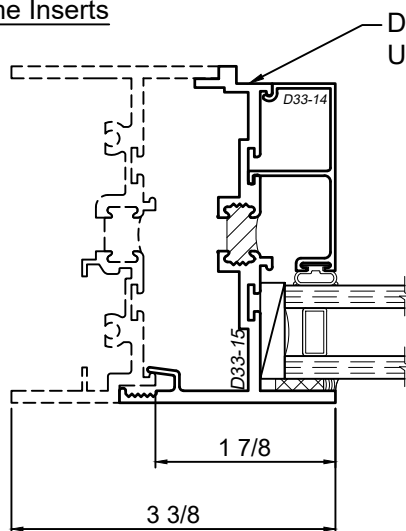

D33-15
Use: reverse any frame member.

Winco has different gaskets and glazing methods that can accommodate odd thicknesses of glass. If you do not see what you are looking for within this chart please contact your local representative for information regarding your specific project needs.

© WINCO WINDOW COMPANY, INC. 2026

HARDWARE - Awning & Hopper Configurations

All exposed locking hardware, strikes and keepers are solid white bronze alloy with US25D brushed finish. All four bar arms, casement arms, friction arms and key release limit arms are stainless steel conforming to AAMA 904.1. Five knuckle butt hinges are fabricated of 6063-T6 aluminum with nylon bushings and a stainless steel hinge pin.

	<p>Project Out Awning (PO) w/ Default Hardware Kit</p> <p>Stainless Steel 4-Bar Hinges PO Cam Lock(s)¹</p>	<p><u>Optional Hardware Accessories:</u> Additional Jamb Mounted Lift Locks Access Control Cam Locks Additional Access Control Jamb Mounted Lift Locks Pole Ring Cam Lock(s)¹ Pole Ring Additional Pole Ring Lift Locks Non-Removable Limit Stop Key-Release Limit Stop</p>
	<p>Project Out Awning (PO) w/ Roto Operator</p> <p>Stainless Steel 4-Bar Hinge Jamb Mounted Lift Locks Pivot Shoe Roto Operator</p>	<p><u>Optional Hardware Accessories:</u> Pole Ring Lift Lock</p> <p>Non-Removable Limit Stop</p>
	<p>Project In Hopper (PI) w/ Default Hardware Kit</p> <p>Stainless Steel 4-Bar Hinges PI Cam Lock(s)¹</p>	<p><u>Optional Hardware Accessories:</u> Additional Jamb Mounted Lift Locks Access Control Cam Locks Additional Access Control Jamb Mounted Lift Locks Pole Ring Cam Lock(s)¹ Pole Ring Additional Pole Ring Lift Locks Non-Removable Limit Stop Key-Release Limit Stop</p>

WINCO RESERVES THE RIGHT TO MODIFY OR CHANGE INFORMATION WITHIN THIS BOOK WHEN DEEMED NECESSARY FOR PRODUCT IMPROVEMENT

© WINCO WINDOW COMPANY, INC. 2026

Please contact WINCO for project specific information

¹ Lock Quantity is dependent on Operable Vent Width & Height, Additional Locks can be specified, but minimum Qty is determined by WINCO Engineering

² Butt Hinge Quantity is dependent on Operable Vent Height, Additional Hinges can be specified, but minimum Qty is determined by WINCO Engineering

³ Combination of Casement Roto Operator and Concealed Hinges requires minimum Operable Vent Width to accommodate Hardware

HARDWARE - Casement Configurations

All exposed locking hardware, strikes and keepers are solid white bronze alloy with US25D brushed finish. All four bar arms, casement arms, friction arms and key release limit arms are stainless steel conforming to AAMA 904.1. Five knuckle butt hinges are fabricated of 6063-T6 aluminum with nylon bushings and a stainless steel hinge pin.

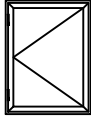
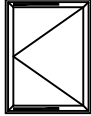
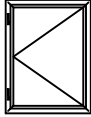
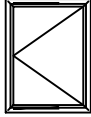
	<p>Project Out Casement (POC) w/ Butt Hinges</p> <p>Butt Hinges² Stainless Steel Friction Adjuster Single Point or Multi-Point Lift Lock(s)¹</p>	<p><u>Optional Hardware Accessories:</u> Casement Roto Operator Access Control Lift Locks Pole Ring Lift Lock(s)¹ Pole Ring Non-Removable Limit Stop Key-Release Limit Stop</p>
	<p>Project Out Casement (POC) w/ Concealed Hinges</p> <p>Stainless Steel 4-Bar Casement Hinges Single Point or Multi-Point Lift Lock(s)¹</p>	<p><u>Optional Hardware Accessories:</u> Casement Roto Operator³ Access Control Lift Locks Pole Ring Lift Lock(s)¹ Pole Ring Non-Removable Limit Stop Key-Release Limit Stop</p>
	<p>Project In Casement (PIC) w/ Butt Hinges</p> <p>Butt Hinges² Stainless Steel Friction Adjuster Single Point or Multi-Point Lift Lock(s)¹</p>	<p><u>Optional Hardware Accessories:</u> Access Control Lift Locks Pole Ring Lift Lock(s)¹ Pole Ring Non-Removable Limit Stop Key-Release Limit Stop</p>
	<p>Project In Casement (PIC) w/ Concealed Hinges</p> <p>Stainless Steel 4-Bar Casement Hinges Single Point or Multi-Point Lift Lock(s)¹</p>	<p><u>Optional Hardware Accessories:</u> Access Control Lift Locks Pole Ring Lift Lock(s)¹ Pole Ring Non-Removable Limit Stop Key-Release Limit Stop</p>

Please contact WINCO for project specific information

¹ Lock Quantity is dependent on Operable Vent Width & Height, Additional Locks can be specified, but minimum Qty is determined by WINCO Engineering

² Butt Hinge Quantity is dependent on Operable Vent Height, Additional Hinges can be specified, but minimum Qty is determined by WINCO Engineering

³ Combination of Casement Roto Operator and Concealed Hinges requires minimum Operable Vent Width to accommodate Hardware