

M-3 Mullion set from Building Interior

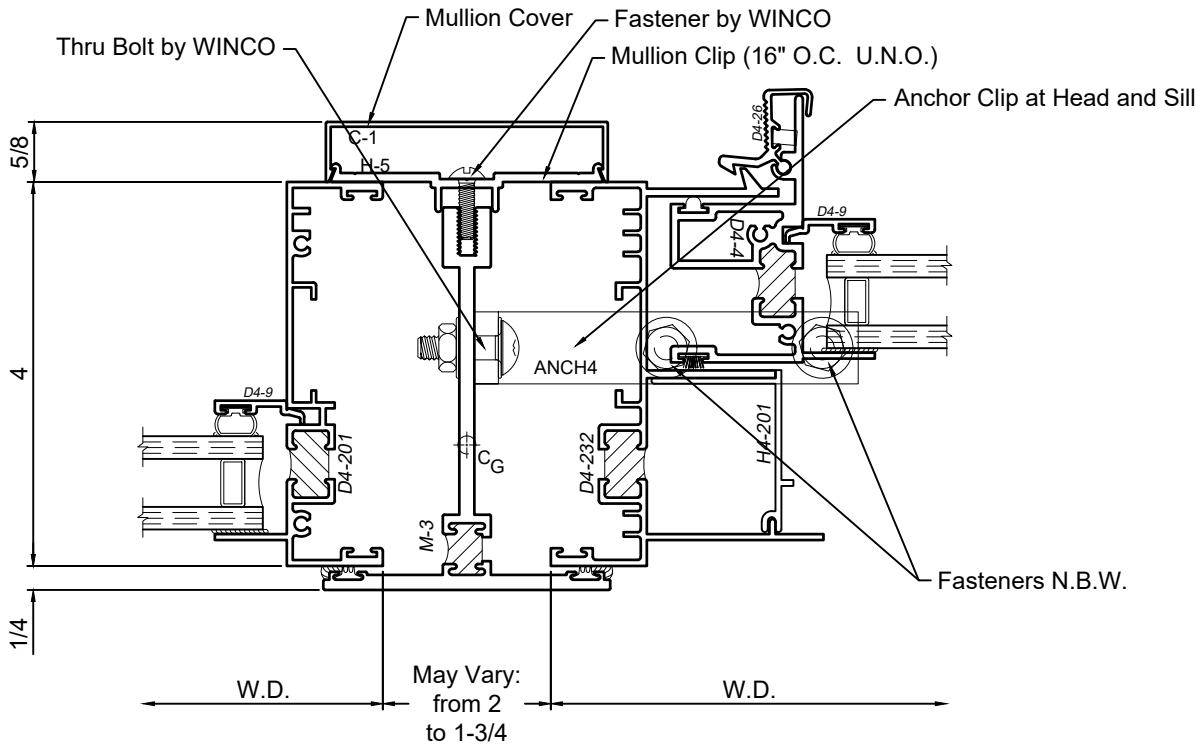

WINCO RESERVES THE RIGHT TO MODIFY OR CHANGE INFORMATION WITHIN THIS BOOK WHEN DEEMED NECESSARY FOR PRODUCT IMPROVEMENT

M-3 Mullion set from Building Exterior

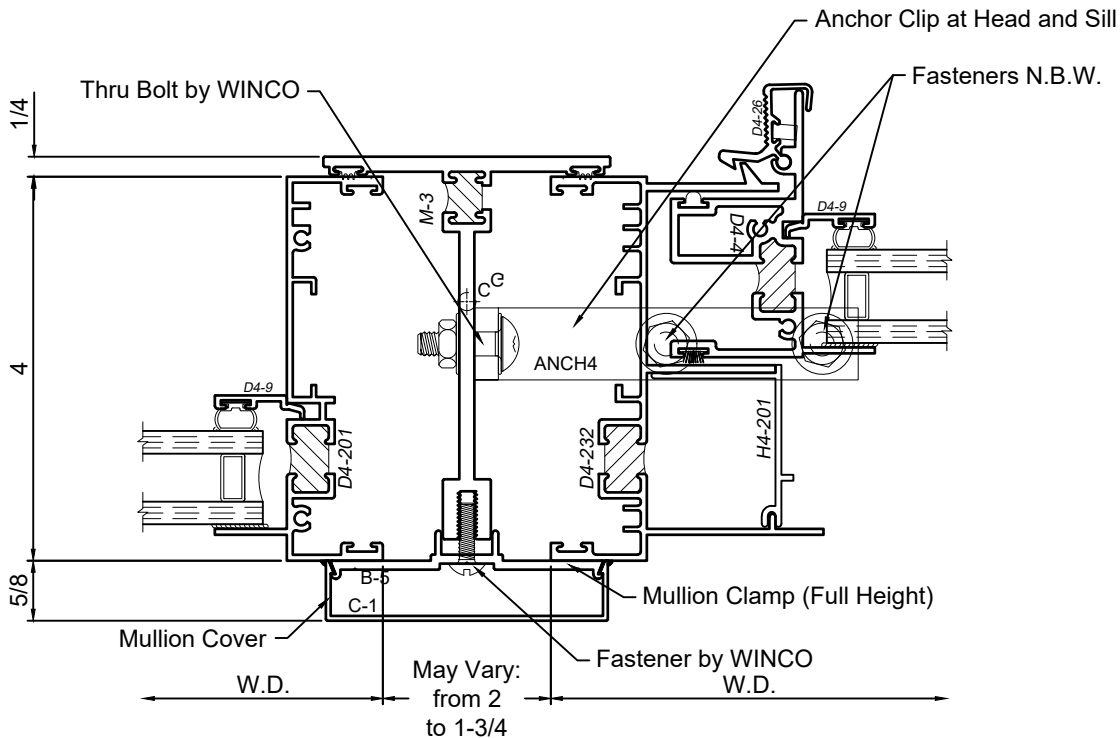

© WINCO WINDOW COMPANY, INC. 2026

SCALE 6"=1'-0"

M-1 Mullion set from Building Interior

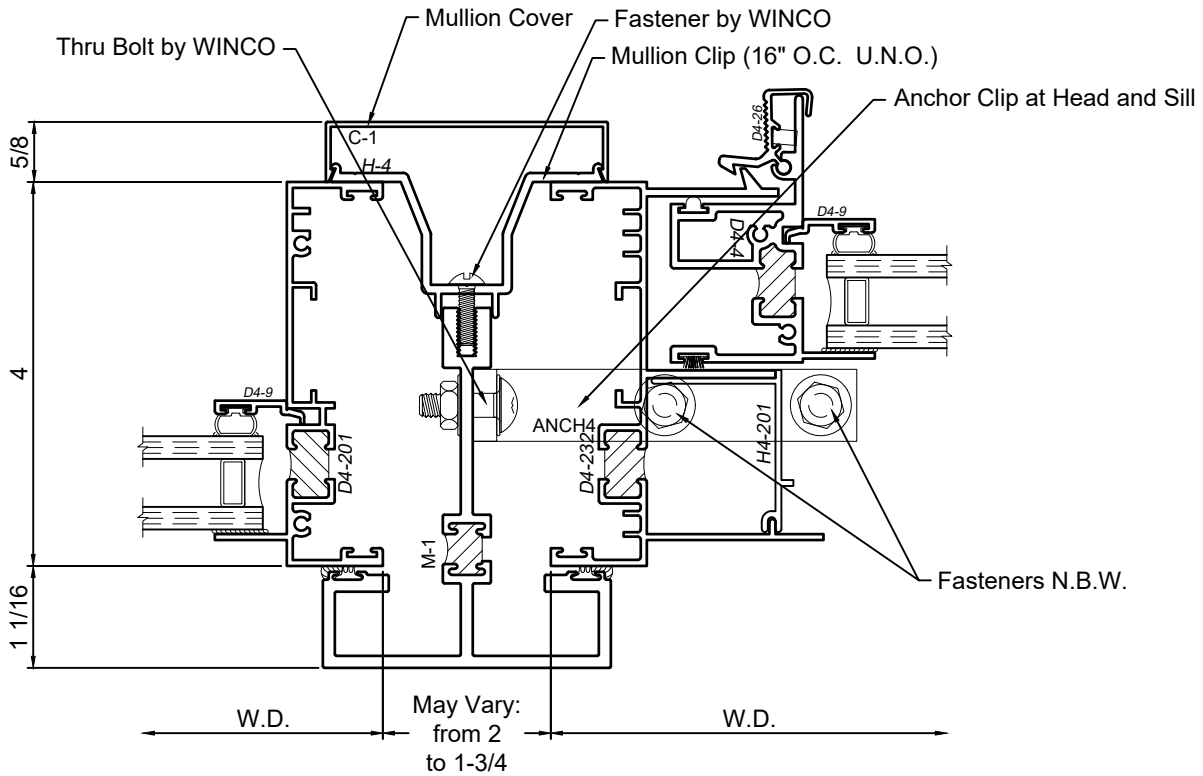

M-1 Mullion set from Building Exterior

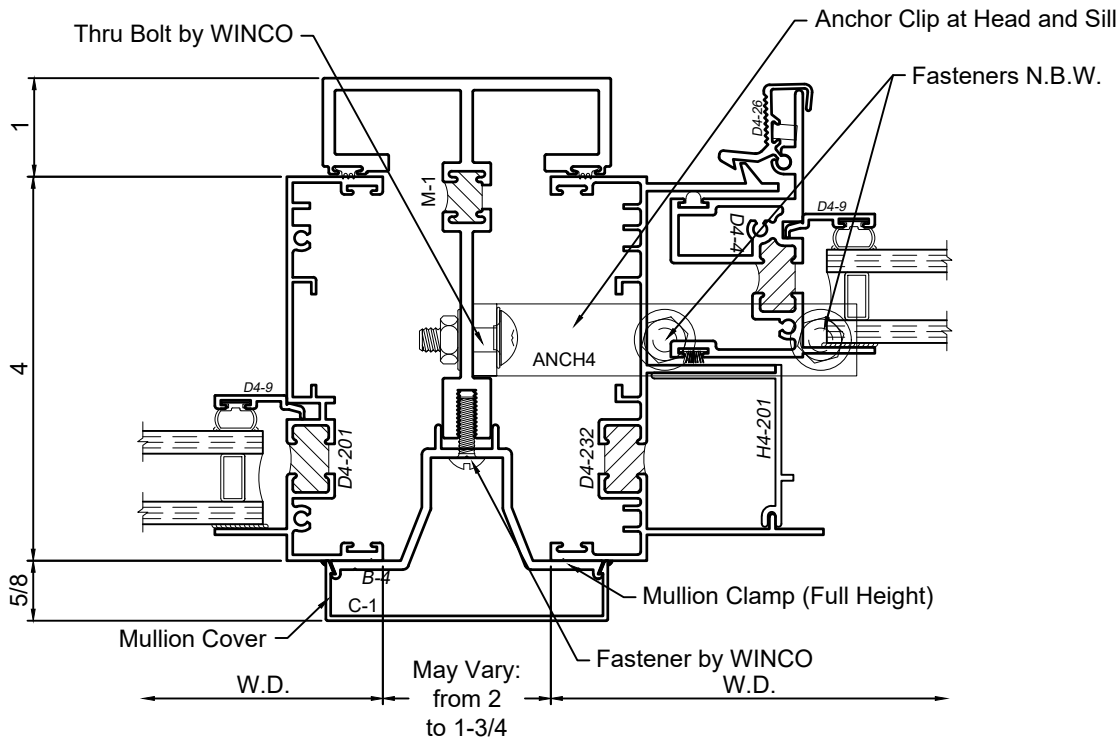

SCALE 6"=1'-0"

WINCO RESERVES THE RIGHT TO MODIFY OR CHANGE INFORMATION WITHIN THIS BOOK WHEN DEEMED NECESSARY FOR PRODUCT IMPROVEMENT

© WINCO WINDOW COMPANY, INC. 2026

WINCO RESERVES THE RIGHT TO MODIFY OR CHANGE INFORMATION WITHIN THIS BOOK WHEN DEEMED NECESSARY FOR PRODUCT IMPROVEMENT

M-2 Mullion set from Building Interior

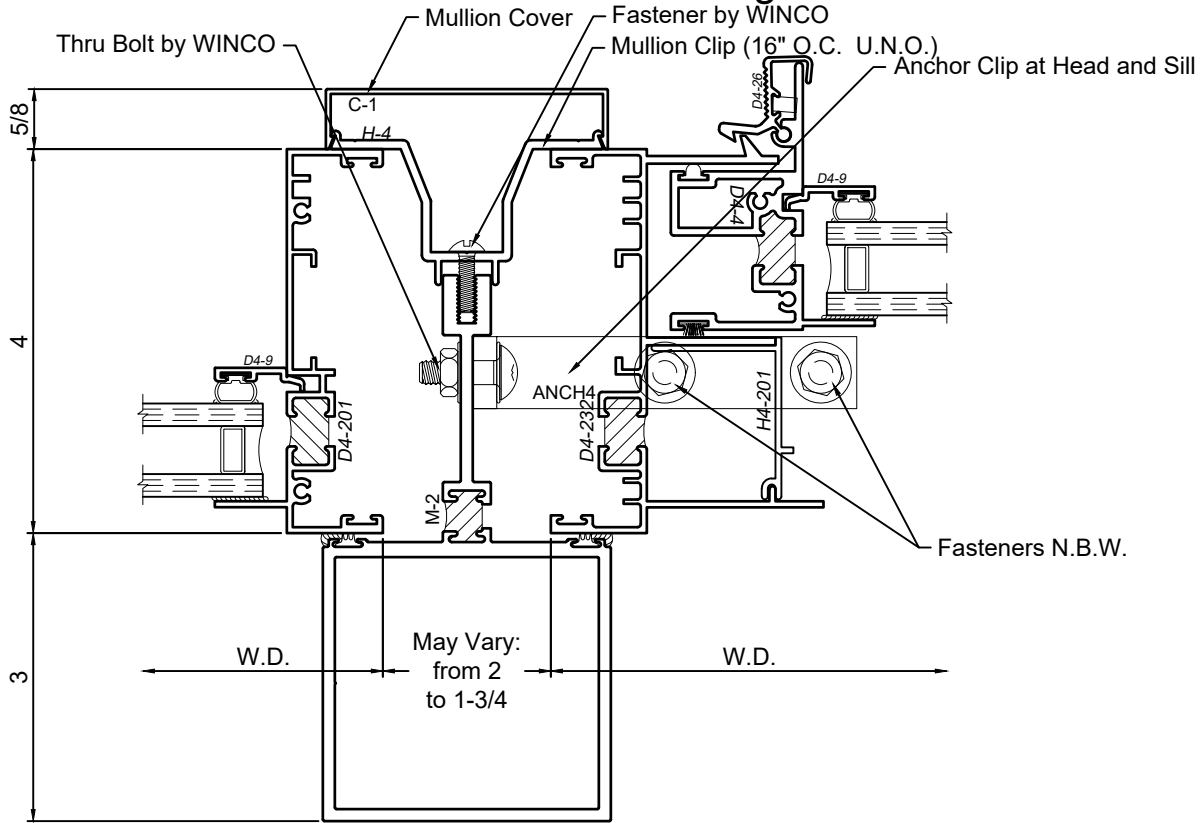

M-2 Mullion set from Building Exterior

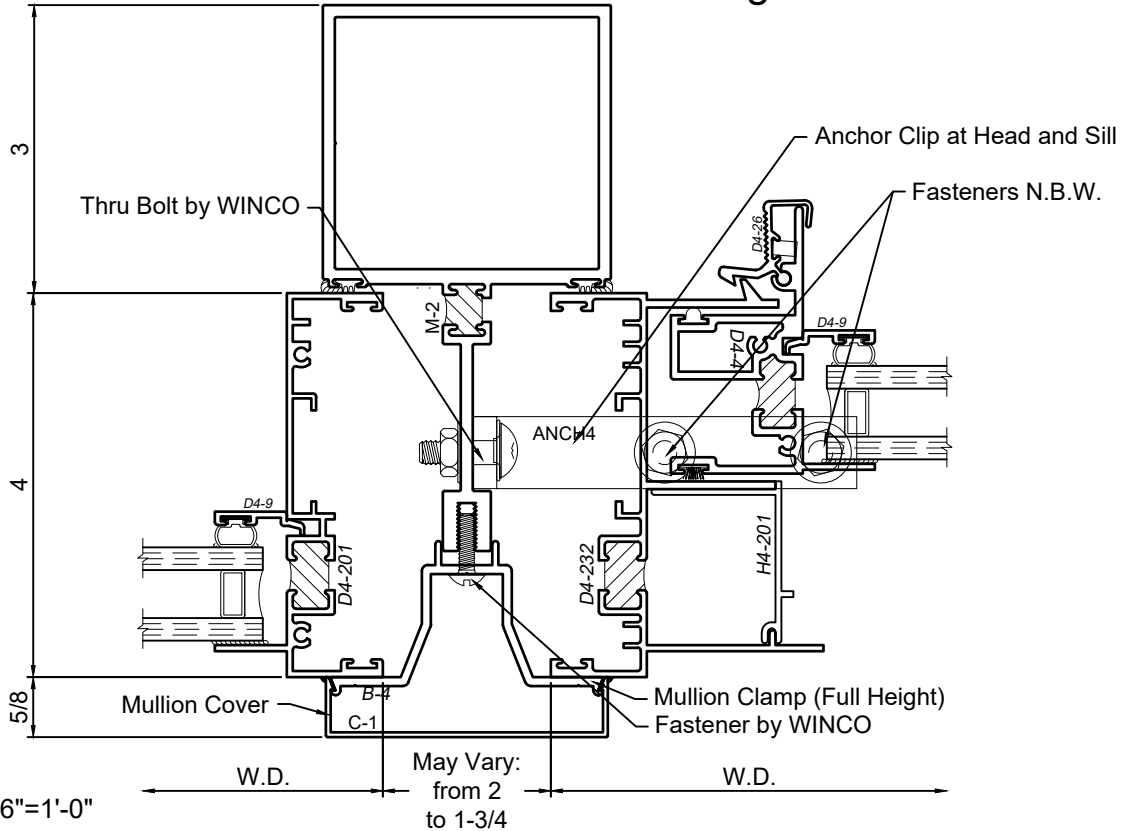

SCALE 6"=1'-0"

M-11 Mullion

Recommended usage only with Jamb Receptor for installation clearances

WINCO RESERVES THE RIGHT TO MODIFY OR CHANGE INFORMATION WITHIN THIS BOOK WHEN DEEMED NECESSARY FOR PRODUCT IMPROVEMENT

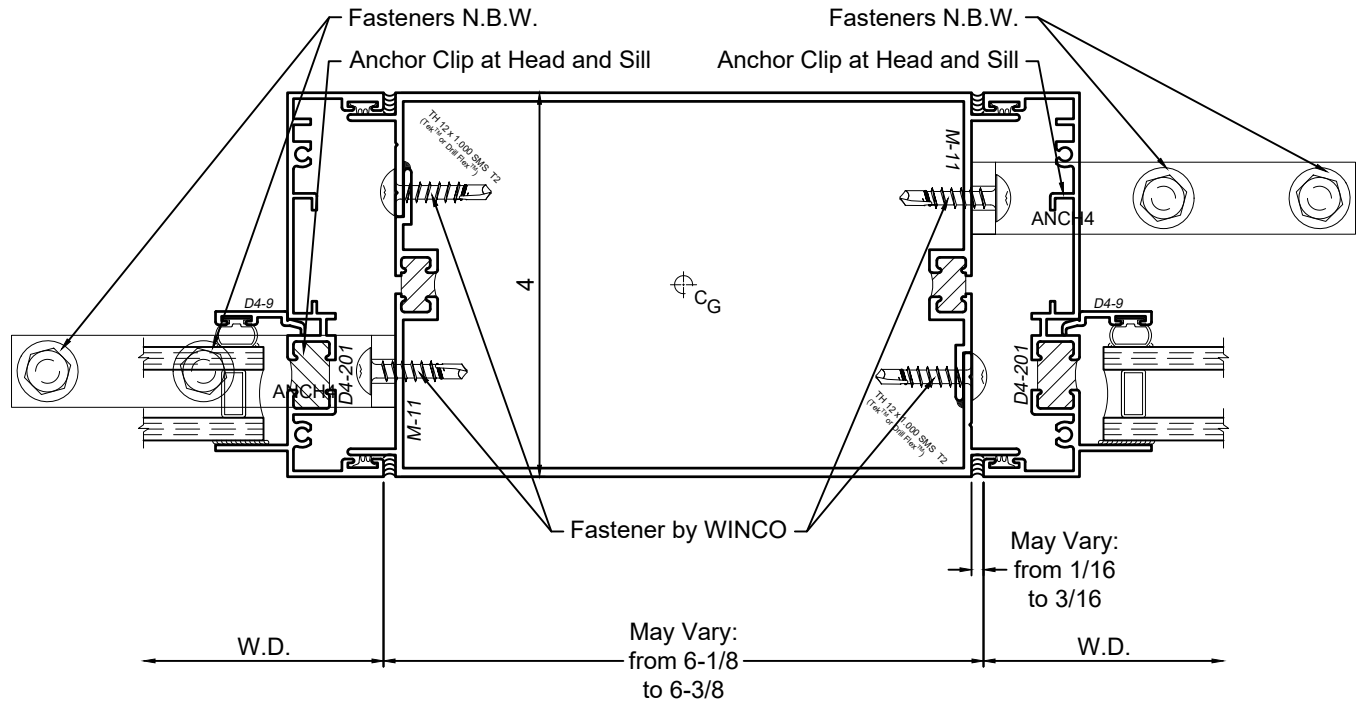

© WINCO WINDOW COMPANY, INC. 2026

SCALE 6"=1'-0"

3410 Series 4" Thermal Fixed & Horizontal Sliding Windows

Product Details - Trim - Mullion



WINCO RESERVES THE RIGHT TO MODIFY OR CHANGE INFORMATION WITHIN THIS BOOK WHEN DEEMED NECESSARY FOR PRODUCT IMPROVEMENT

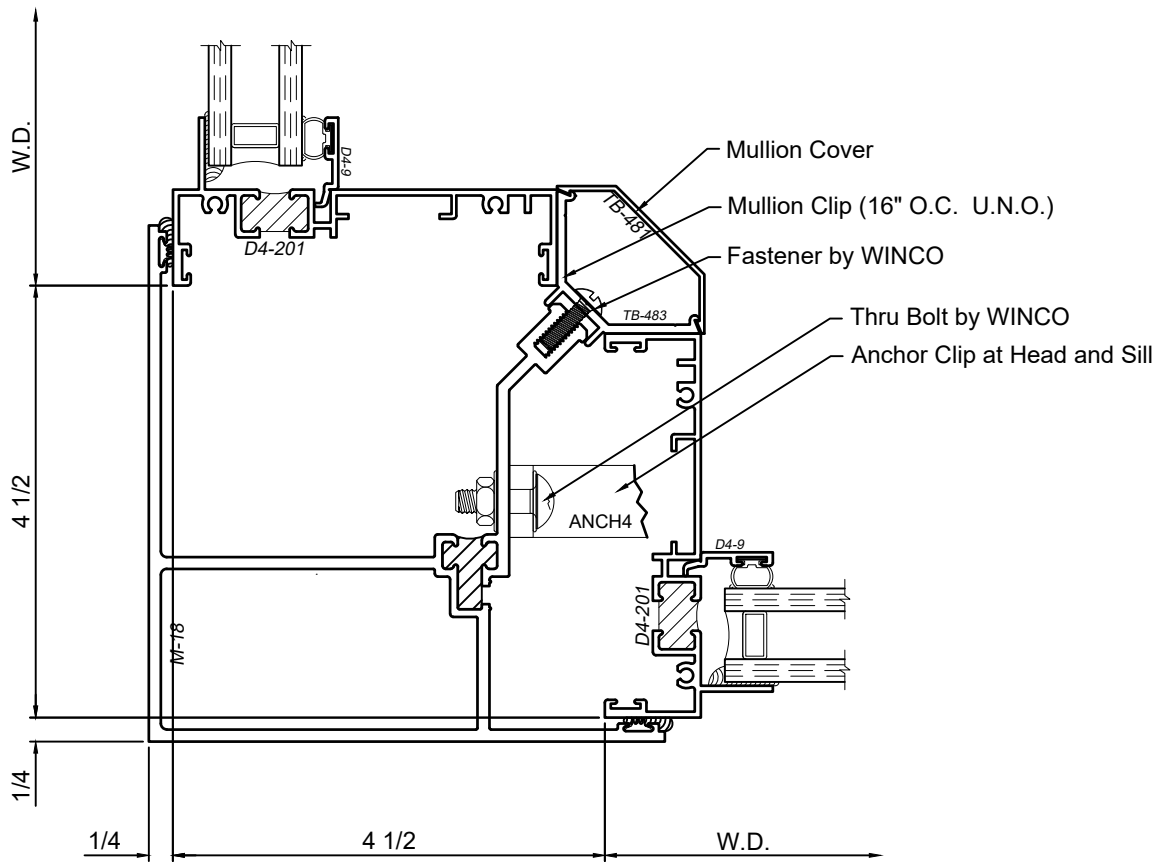

© WINCO WINDOW COMPANY, INC. 2026

SCALE 6"=1'-0"