

Mullion Sections - 4410 Series

Product Details - M-3 Mullion



Note: Trim shown is a sampling of WINCO's offering. Not all shapes are held in stock and minimum quantity order may be required. Consult your local WINCO sales representative for other trims available. It is WINCO's recommendation to install all trim and materials per WINCO's installation instructions.

M-3 Mullion set from Building Interior

WINCO RESERVES THE RIGHT TO MODIFY OR CHANGE INFORMATION WITHIN THIS BOOK WHEN DEEMED NECESSARY FOR PRODUCT IMPROVEMENT

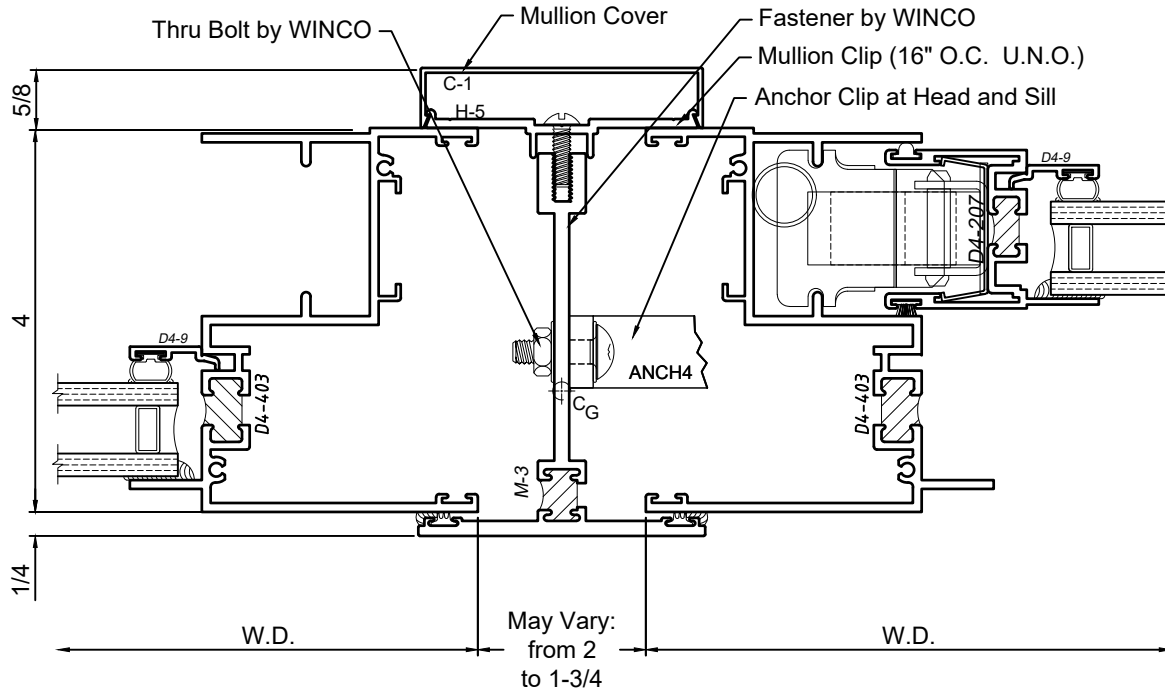

M-3 Mullion set from Building Exterior

© WINCO WINDOW COMPANY, INC. 2026

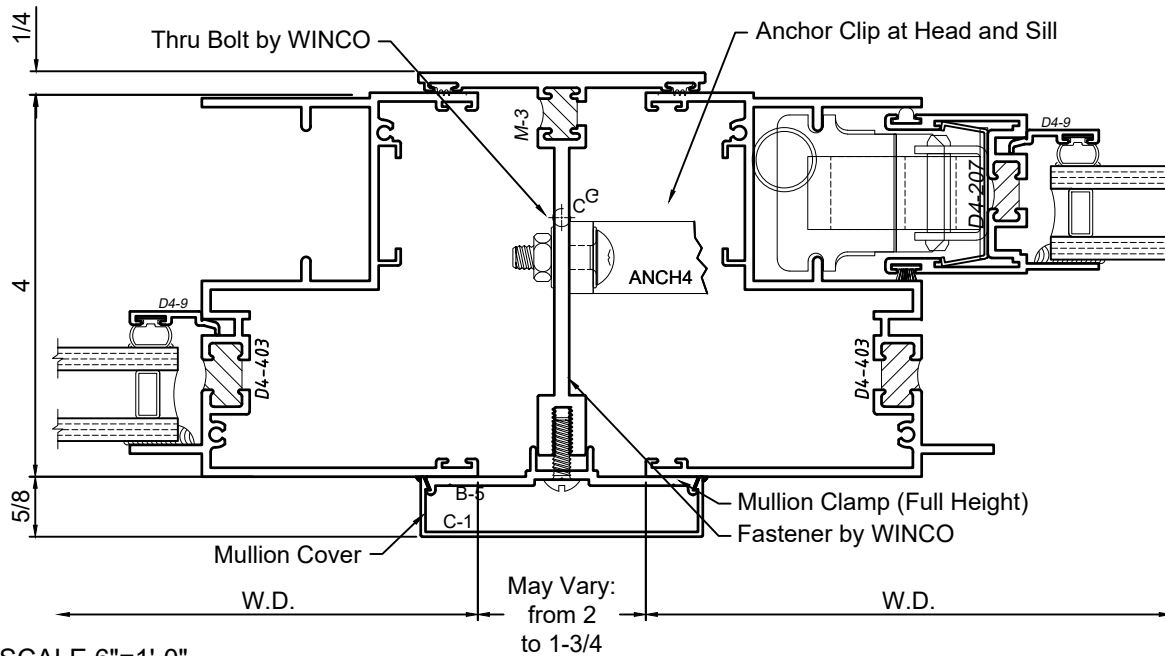

SCALE 6"=1'-0"

Mullion Sections - 4410 Series

Product Details - M-1 Mullion



Note: Trim shown is a sampling of WINCO's offering. Not all shapes are held in stock and minimum quantity order may be required. Consult your local WINCO sales representative for other trims available. It is WINCO's recommendation to install all trim and materials per WINCO's installation instructions.

WINCO RESERVES THE RIGHT TO MODIFY OR CHANGE INFORMATION WITHIN THIS BOOK WHEN DEEMED NECESSARY FOR PRODUCT IMPROVEMENT

M-1 Mullion set from Building Interior

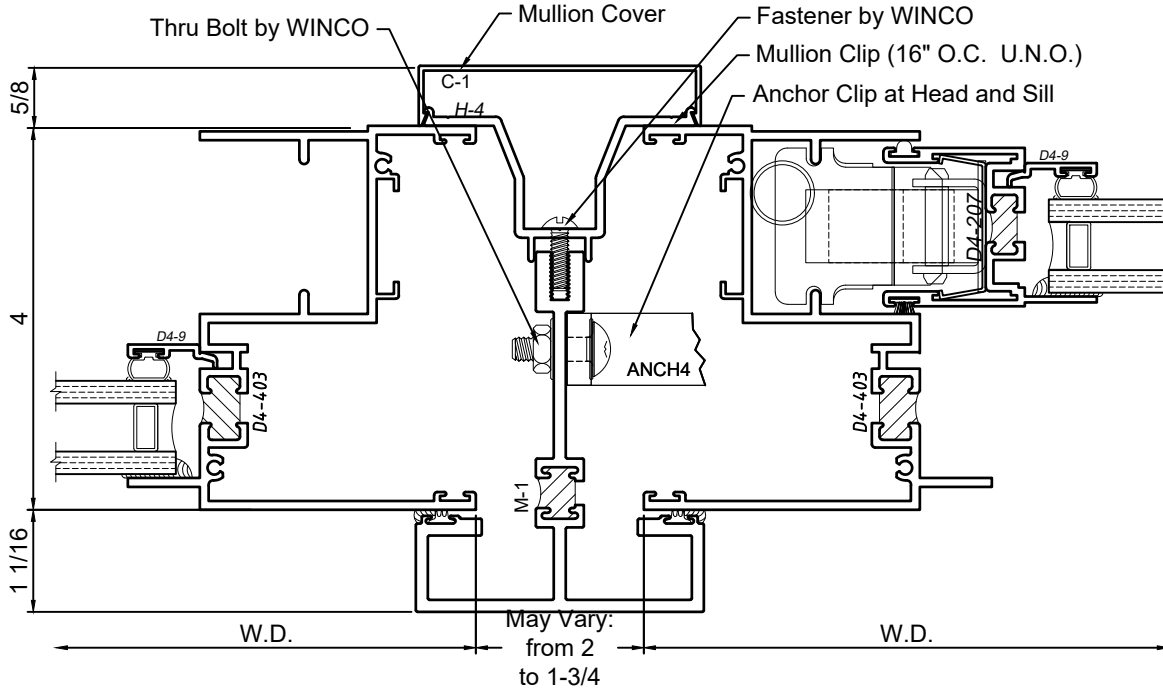

M-1 Mullion set from Building Exterior

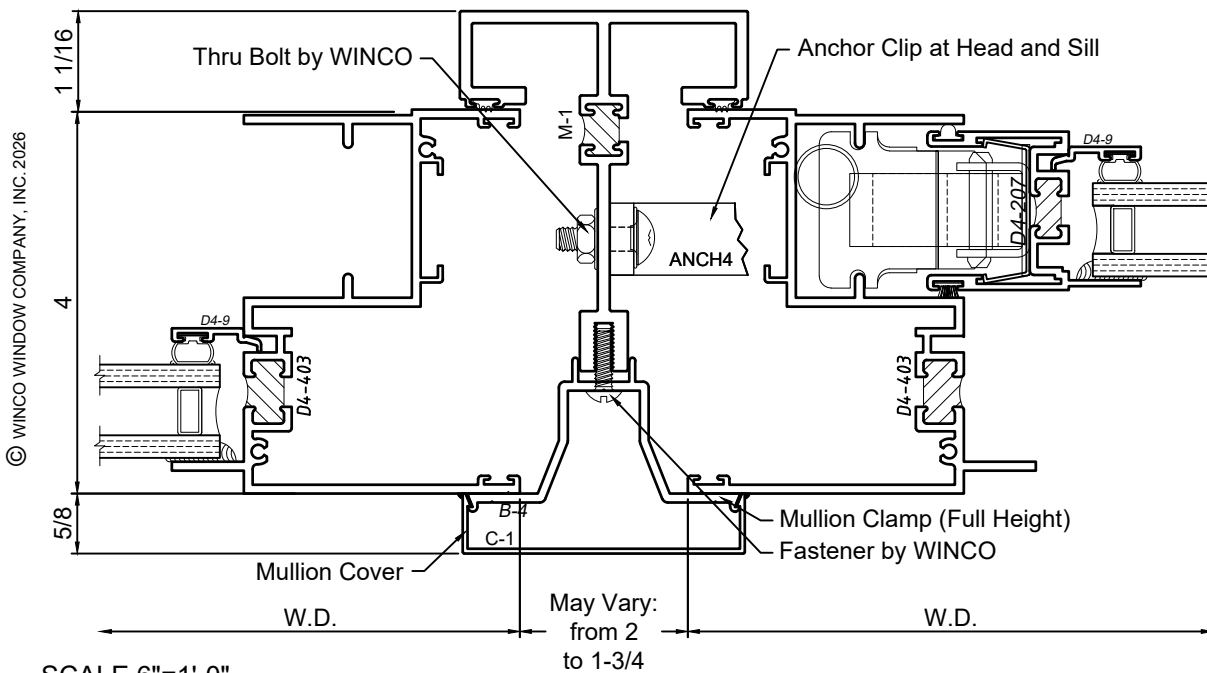

SCALE 6"=1'-0"

Mullion Sections - 4410 Series

Product Details - M-2 Mullion



Note: Trim shown is a sampling of WINCO's offering. Not all shapes are held in stock and minimum quantity order may be required. Consult your local WINCO sales representative for other trims available. It is WINCO's recommendation to install all trim and materials per WINCO's installation instructions.

WINCO RESERVES THE RIGHT TO MODIFY OR CHANGE INFORMATION WITHIN THIS BOOK WHEN DEEMED NECESSARY FOR PRODUCT IMPROVEMENT

M-2 Mullion set from Building Interior

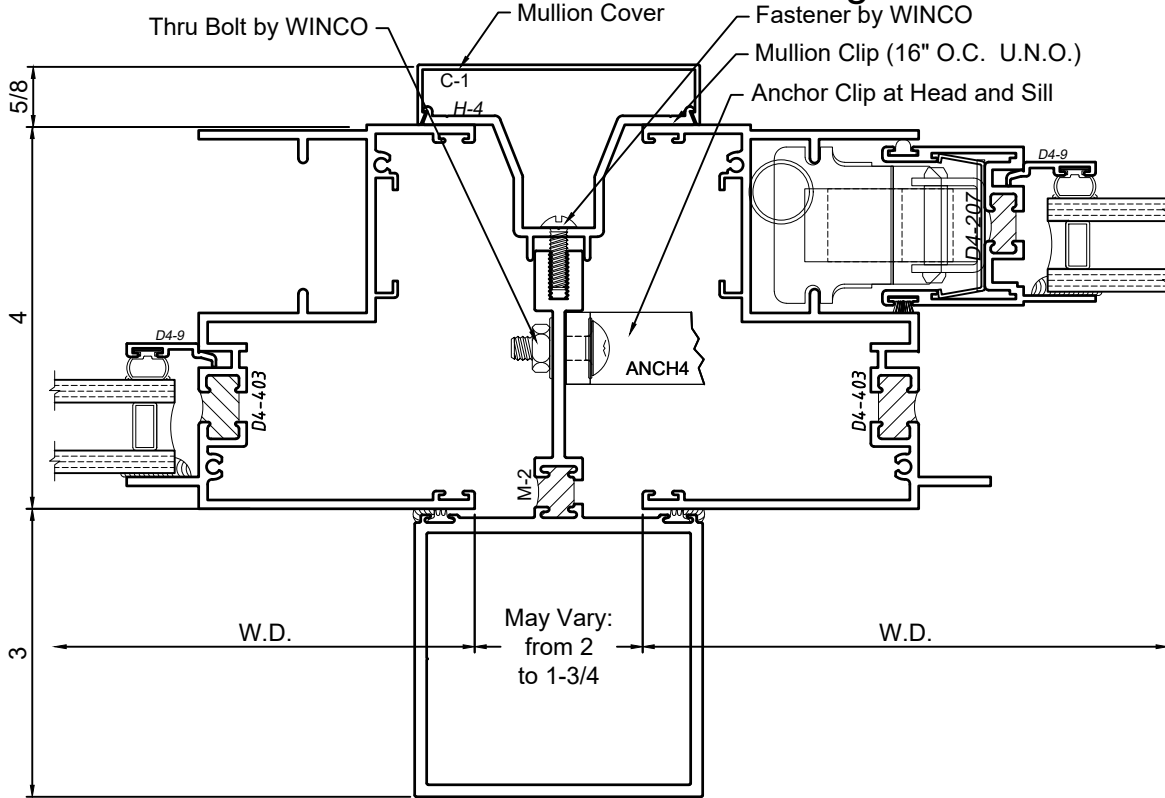

M-2 Mullion set from Building Exterior

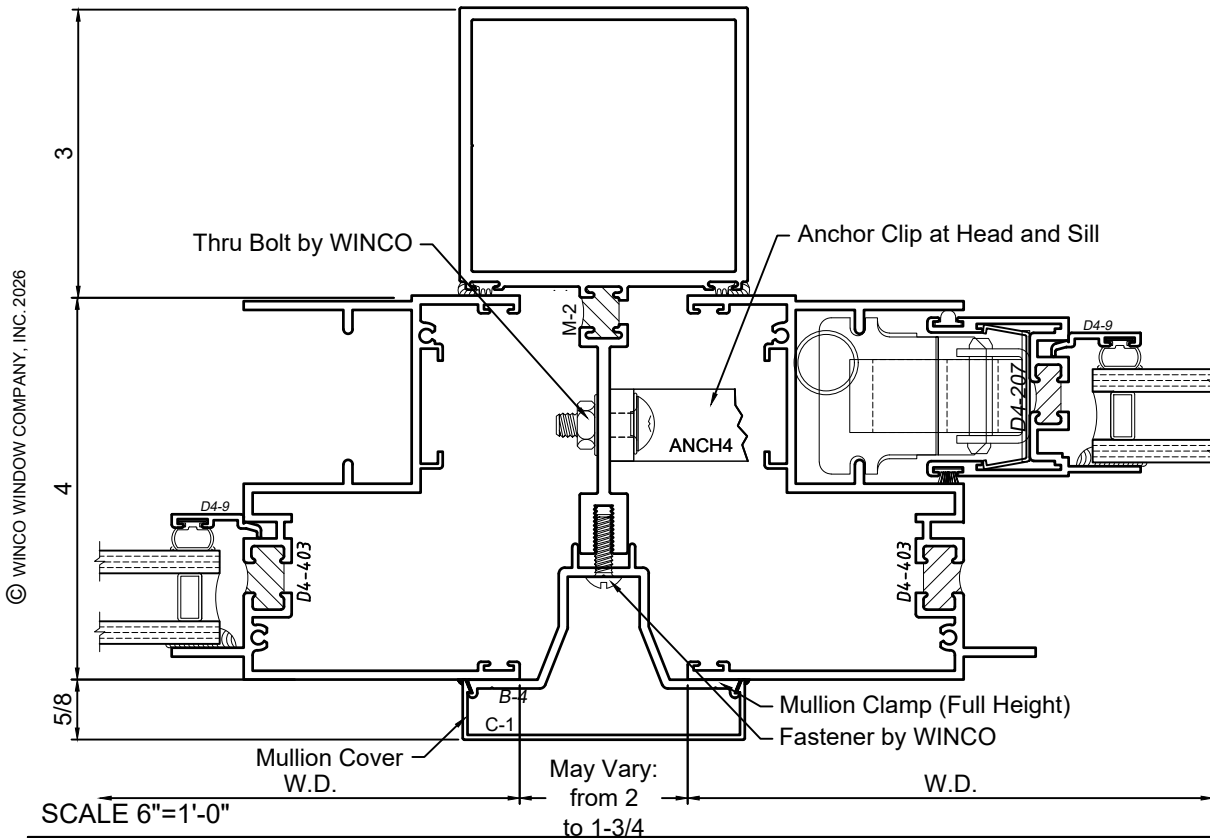

© WINCO WINDOW COMPANY, INC. 2026

Mullion Sections - 4410 Series

Product Details - 90° Corner Mullion



Note: Trim shown is a sampling of WINCO's offering. Not all shapes are held in stock and minimum quantity order may be required. Consult your local WINCO sales representative for other trims available. It is WINCO's recommendation to install all trim and materials per WINCO's installation instructions.

WINCO RESERVES THE RIGHT TO MODIFY OR CHANGE INFORMATION WITHIN THIS BOOK WHEN DEEMED NECESSARY FOR PRODUCT IMPROVEMENT

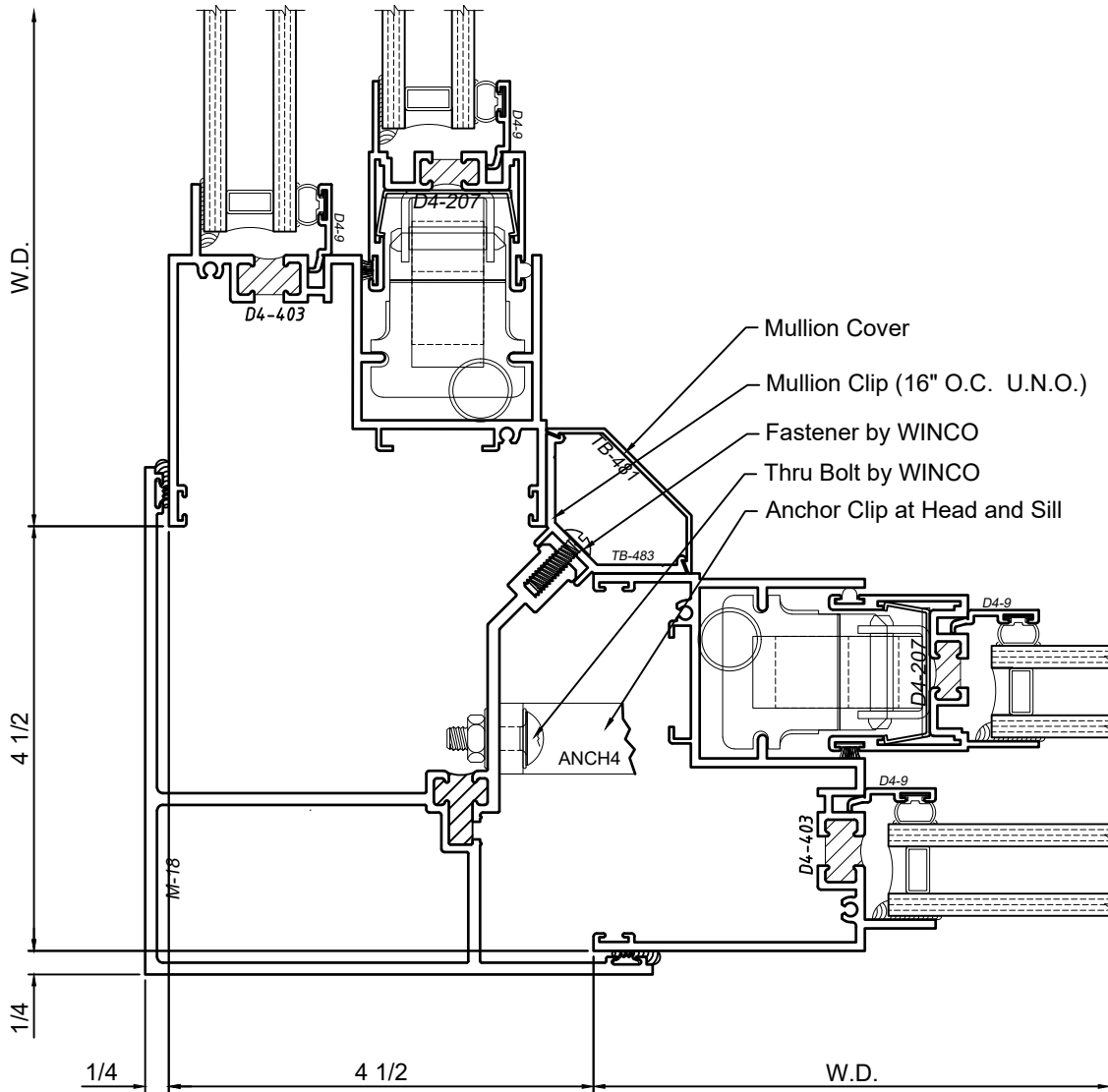

© WINCO WINDOW COMPANY, INC. 2026

SCALE 6"=1'-0"

Mullion Sections - 4410 Series

Product Details - M-11



Note: Trim shown is a sampling of WINCO's offering. Not all shapes are held in stock and minimum quantity order may be required. Consult your local WINCO sales representative for other trims available. It is WINCO's recommendation to install all trim and materials per WINCO's installation instructions.

WINCO RESERVES THE RIGHT TO MODIFY OR CHANGE INFORMATION WITHIN THIS BOOK WHEN DEEMED NECESSARY FOR PRODUCT IMPROVEMENT

M-11 Mullion

Recommended usage only with Jamb Receptor for installation clearances

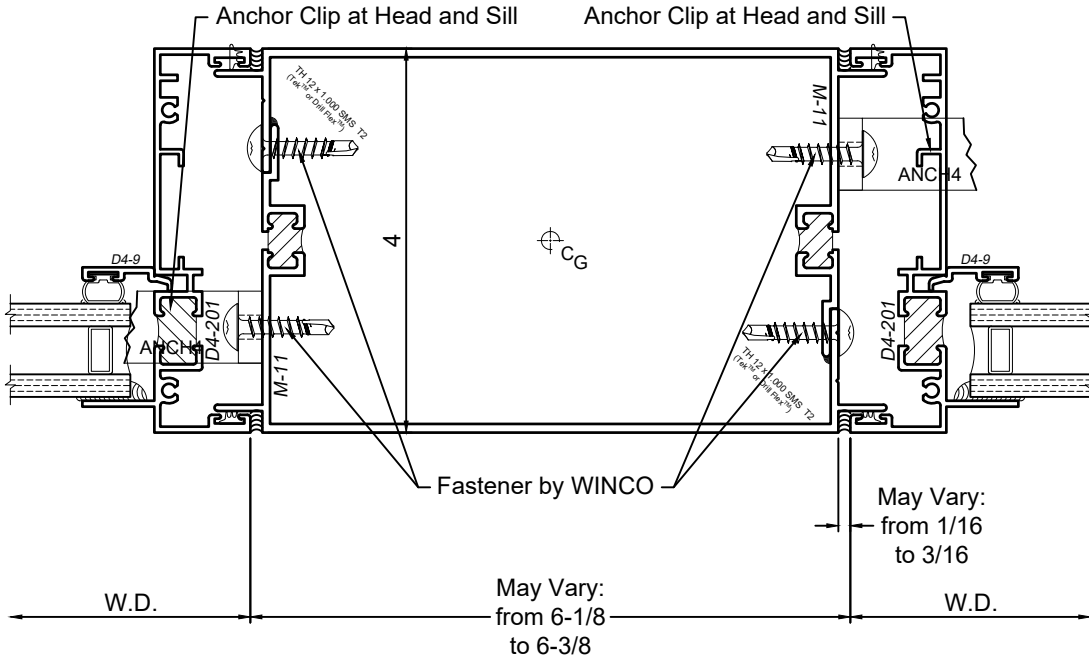

© WINCO WINDOW COMPANY, INC. 2026

SCALE 6"=1'-0"