

8325 Series 3-1/4" Thermal Fixed, Casement & Projected Windows

Product Details - Project In - Hopper



Note: Multiple configurations of this window system are available. Refer to the WINCO website for additional options or contact your local WINCO Sales Representative for information.

WINCO RESERVES THE RIGHT TO MODIFY OR CHANGE INFORMATION WITHIN THIS BOOK WHEN DEEMED NECESSARY FOR PRODUCT IMPROVEMENT

© WINCO WINDOW COMPANY, INC. 2026

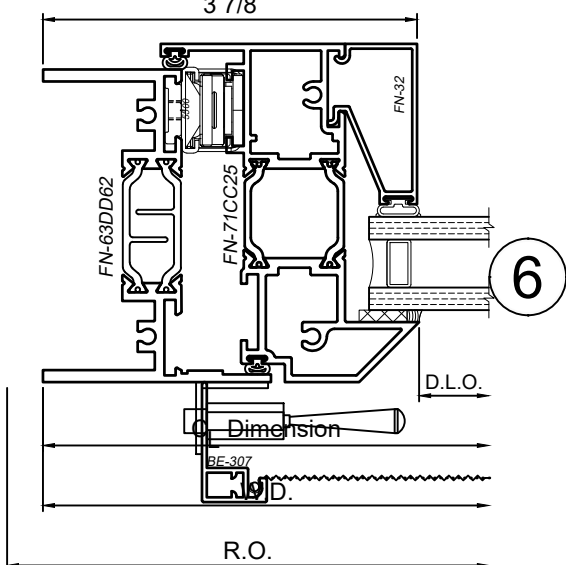
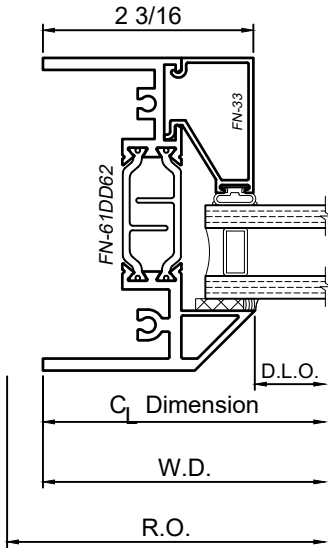
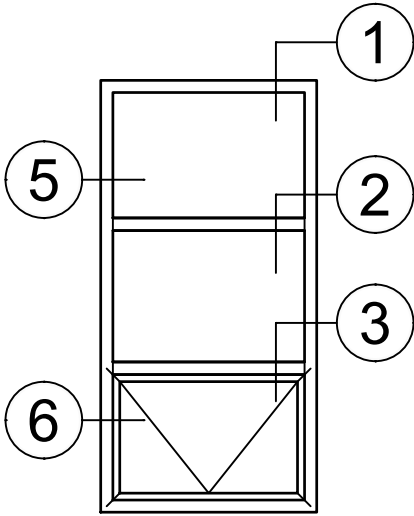

SCALE 6"=1'-0"

