

4" Thermal Hung Replica and Slider Replica Windows

Product Details - Simulated Slider Jamb Details [SR-2,5 & 8]



Note: Multiple configurations of this window system are available. Refer to the WINCO website for additional options or contact your local WINCO Sales Representative for information.

WINCO RESERVES THE RIGHT TO MODIFY OR CHANGE INFORMATION WITHIN THIS BOOK WHEN DEEMED NECESSARY FOR PRODUCT IMPROVEMENT

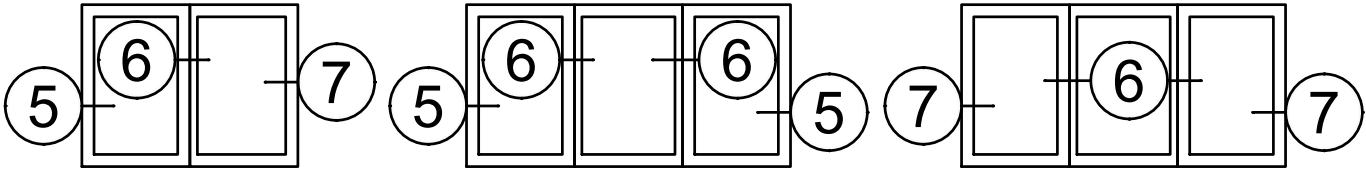

SR-2

SR-5

SR-8

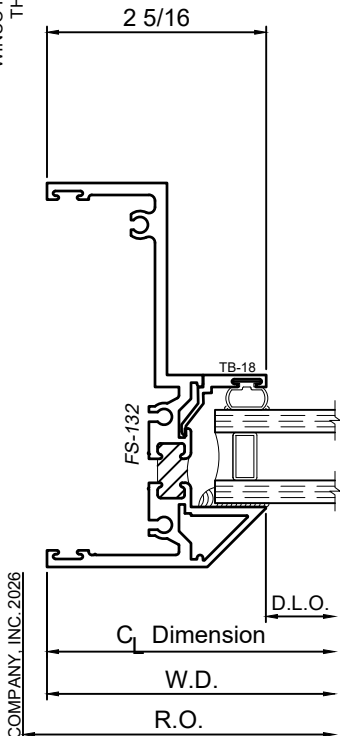

5

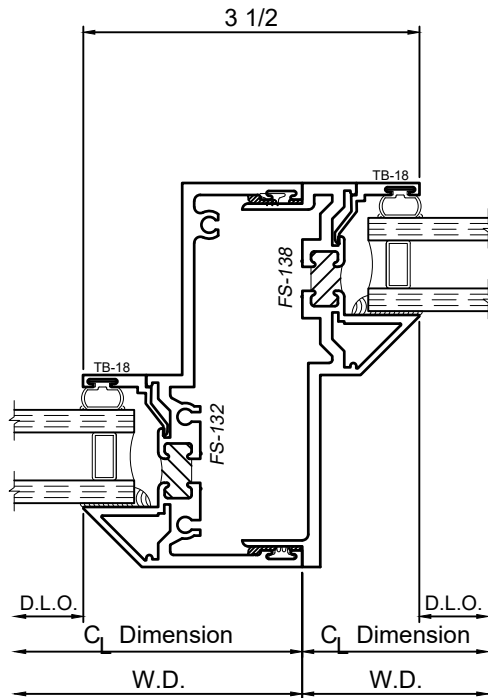

6

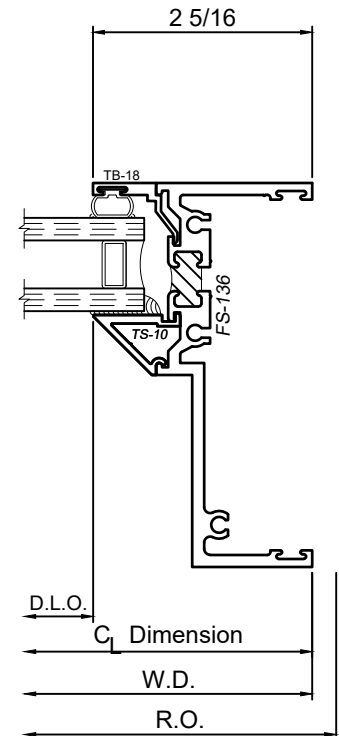

7

© WINCO WINDOW COMPANY, INC. 2026

SCALE 6"=1'-0"